

**Model Two  
HD<sup>®</sup>CD  
A/D Converter  
D/A Converter  
Digital Processor**

**User's Manual  
Version 3.01**

PN 9300-0020 Rev. C



Euphonix, Inc.  
220 Portage Avenue, Palo Alto, CA 94306  
Phone (650) 855-0400 Fax (650) 855-0410

This User's Manual contains information needed to properly install and operate the Model Two. **Please read the Installation section before connecting AC power!** The Installation and Set Up & Operation sections of this manual should also be read before first use of the Model Two.

Model Two User's Manual Versions correspond to Model Two Software Versions. Verify that the Software Version listed on page one of this manual matches the Version listed in the Software Version Menu accessible through the Model Two's Graphic Display. For details, see page 65 in the Reference Section. If the Versions do not match, please contact Euphonix to obtain the correct User's Manual, or update the Software Version.

*Euphonix is committed to the ongoing support of our products and customers. If we can be of assistance in any way, please call us at (650) 855-0400, Monday through Friday, between 9:00 AM and 5:00 PM Pacific Time, or fax us at (650) 855-0410. You can also contact customer service by visiting our Web site at [www.euphonix.com](http://www.euphonix.com). For additional information on HDCD products and technology, please visit [www.hdcd.com](http://www.hdcd.com).*

©2002 Euphonix, Inc.  
All rights reserved.

## Installation

- Model Two Processor, 4
- Model Two Power Supply, 4
- DC Power Cable, 4
- AC Power Cable, 4
- Power Up, 5
- Setting Analog Connector Pin Polarity, 5
- Setting Analog Input Attenuation, 6
- Analog Connections, 7
- Analog Output Networks, 7
- Digital Connections, 7
- AES Signal Ground Isolators, 8
- Model Two Processor Description, 9
- Model Two Processor Front Panel Controls, 9
- Model Two Processor Rear Panel, 10
- Model Two Power Supply Description, 11

## Setup & Operation

- Model Two Rev. 3.01 Software Features, 12
- Front Panel Controls and Displays, 13
- Signal Level Meter, 13
  - Meter Source, 14
  - Meter Display Mode, 14
  - Peak Level Hold, 14
  - Signal Over Segments, 15
- Peak Extension/HDCD Limiting Meters, 15
- Meter Reset Button, 15
- Meter Setup, 15
- Monitoring, 16
- Power Switch, 16
- Graphic Display, 17
- Menu Up and down Buttons, 17
- Function Buttons, 17
- Enter Button, 17
- Rotary Control, 17
- System Status Indicator, 18
- Clock Indicators, 18
- HDCD Indicator, 18
- Operating Modes, 19-23
- Presets, 24
- Factory Preset Configurations, 24-25
- Using the Model Two as a Master Word Clock Generator, 26
  - Setup for AD and DD Operating Modes, 26
  - Setup for AD and DD Multichannel Operation, 26-27
- Recording From an Analog Source, 27
  - Setup for 44.1/48 kHz, 88.2/96 kHz and 176.4/192 kHz A/D Conversion, 27-29
  - Setup for 44.1/48kHz A/D conversion With Simultaneous D to D Processing, 29
- Digital Post Production Processing, 30
  - Setup for 44.1 kHz Word Length Conversion & HDCD 16-bit Encoding, 30
  - Setup for 88.2/96 kHz to 44.1/48 kHz Decimation & Word Length Conversion, 30
  - Setup for 44.1/48 kHz to 88.2/96 kHz Interpolation & Word Length Conversion, 31
  - Setup for 176.4/192 kHz to 44.1/48 kHz Decimation & Word Length Conversion, 32
  - Setup for 44.1/48 kHz to 176.4/192 kHz Interpolation & Word Length Conversion, 32
- DAC-Monitoring System Performance Optimization, 32-33
- Compact Disc Release Mastering, 33
  - HDCD Silence, 33
  - Processing HDCD 16-bit Signals, 33
- A/D Conversion of Analog Tape Recordings, 34
- Creating the 16-Bit HDCD Release Sound You Want, 35
- HDCD16-bit Amplitude Encoding & Dither Options, 35
  - Peak Extension & HDCD Limiting, 35
  - DSP Gain, 36
  - Low Level Extension, 36

- HDCD 16-bit Dithers, 37
- Operating Techniques, 37
  - Limited Dynamic Range Pop or Rock, 37
  - Wide Dynamic Range Jazz or classical, 38

## Reference

- Menu Structure, 39
- Menu Tree, 40
- Menu Descriptions, 41
  - Operating Menu, 41
  - Second Operating Menu, 41
  - Monitor Source Menu, 42
  - Levels Menu, 42-44
  - Setup Menu, 44-45
  - 44.1/48 Base Sample Rate Menu, 45
  - Operating Mode 1\_X Modes Menu, 46
  - Operating Mode 2\_X Modes Menu, 46
  - Operating Mode 4\_X Modes Menu, 47
  - Digital Output Menu, 47-48
  - Digital Output 1 Word Length Menu, 48
  - Output 1 HDCD\_16 Dither Menu, 48-49
  - Digital Output 2 Word Length Menu, 49
  - Output 2 HDCD\_16 Dither Menu, 50
  - Digital Output Word Length Menu, 50
  - Digital Output Phase Invert Menu, 51
  - Digital Output HDCD Setup Menu, 51
  - Digital Output Format Menu, 52
  - Analog Input Menu, 52
  - A/D Reference Clock Menu, 53
  - A/D Filter Mode Menu, 53
  - Monitor Input HDCD Code Detect Menu, 54
  - Monitor Reference Clock Menu, 54
  - External Ref Clock Frequency Menu, 55
  - Monitor Digital Input Format Menu, 55
  - Digital Input Menu, 56
  - Digital Input HDCD Code Detect Menu, 56
  - Digital Input HDCD\_16 Decoding Menu, 57
  - 2X To 1X Filter Mode Menu, 57
  - Digital In Reference Clock Menu, 58
  - Digital Input Format Menu, 58
  - Recall Presets Menu, 59
  - System Menu, 59
  - Front Panel Display Menu, 60
  - Analog Polarity Menu, 60
  - DAC-System Optimize Menu, 60
  - Monitor Setup Menu, 61
  - Meter Setup Menu, 61
  - Meter Overload Light #1 Menu, 62
  - Meter Overload Light #2 Menu, 62
  - Store Presets Menu, 63
  - Store Preset Menu, 63
  - Rename Preset Menu, 64
  - Test Functions Menu, 64
  - Software Version Menu, 65
- System Software Download, 65
  - Background, 65
  - Required Equipment, 65
  - Download Procedure, 66-67
- Self-Test, 67
- HDCD Overview, 68
  - 16-bit Encoding, 68
  - 16-bit Decoding, 68
  - HDCD Indicator, 69
  - Peak Extension and HDCD Limiting, 69
  - Low Level Extension, 70
  - Gain Scaling, 70
  - Processing HDCD 16-Bit Signals, 70
  - HDCD Silence, 70
- Technical Specifications, 71-72
- Appendix, 73-74

---

## Initial Configuration

---

**PLEASE: Read the following installation instructions BEFORE connecting AC power!**

---

### Model Two Processor

---

The Processor should be placed in an area free from noise generating devices such as power supplies and power amplifiers. At least six inches should be provided to the rear of the unit to allow for heat dissipation and airflow. A vibration isolated fan stabilizes the Processor's thermal environment. The Processor is designed for rack mounting, with four front panel mounting holes and two rear rack mounting brackets, which must be used unless the Processor is supported by a shelf. The rear brackets are included, but are not installed on the unit when shipped.

A description of the Processor is on page 9 and its I/O connections are shown on page 10.

### Model Two Power Supply

---

The Power Supply should not sit directly on top of or underneath the Processor. Note that the Power Supply does not have a power switch and is active only when connected to the Processor unit via the DC power cable and the Processor power is turned on.

A description and illustration of the Power Supply is on page 11.

### DC Power Cable

---

**CAUTION: Do not connect or disconnect the DC power cable from the Processor or Power Supply while the Power Supply AC power cable is plugged in. Always unplug the AC power cable before connecting or disconnecting the DC power cable.**

The receptacle (female) end of the DC power cable is connected to the DC Power Input on the back of the Processor, and the plug (male) end is connected to the DC Output on the Power Supply. The connectors are keyed to ensure correct alignment and have a silver dot at the "up" or 12 o'clock position.

### AC Power Cable

---

**CAUTION: Set the Power Supply AC Line Voltage before connecting the AC power cable!** Line Voltage settings are 100V, 120V, 220V, and 240V, 50/60 Hz, + 5% to - 10%. Total power consumption is 200 Watts. If you are unsure of the actual line voltage, measure it before connecting!

When connecting to 120 volt AC power, use a grounded three prong IEC plug and cord set. When connecting to 100, 220, or 240 volt AC power, use a proper grounded plug and cord set for that application.

AC power for the Model Two should be supplied by the same circuit and preferably the same power outlet group as the AC power source for other equipment, such as analog tape machines or consoles, whose outputs will be connected to the Model Two's analog inputs. This will minimize the possibility of ground loops.

## Power Up

Press the Power Switch on the Processor front panel to turn on the Processor and Power Supply. The System Status Indicator will be lit orange, the A/D and D/A Clock Indicators will be lit green, and the HDCD Indicator will be lit purple. The Graphic Display will momentarily display the following messages: "HDCD BOOT VERSION", "STARTING HDCD..." and "Loading DSP#1.." through "#8". The System and Clock Indicators will then usually indicate normal operation (green) and the HDCD Indicator will go dark or remain lit depending on system set up. Power up is complete when an Operating Menu appears on the Graphic Display similar to the one shown below.

```
OPERATING MENU          ANALOG TO 44.1
                        OUTPUT 1:  HDCD16
                        OUTPUT 2:  HDCD24
                        REF LEVEL: -14
NORMAL  OUT_1
FINE    OUT_2
BITS    DIG_IN
MTRMODE MTRSRCE OPS 2  LEVELS  SETUP
```

At power up all settings will remain as they were prior to power off. From the Operating Menu, all Processor functions are accessible. Function buttons (see page 17) are used to navigate through menus and select items within the menus. Selected items become active by pressing the ENTER button, or by toggling between selections. At any time, the Operating Menu can be accessed by pressing and holding the MENU UP button.

## Setting Analog Connector Pin Polarity

The Processor allows the XLR connector pin polarity of the analog input and outputs to be set to either pin 2 or 3 hot. The factory default setting is pin 2 hot. To verify or change the polarity setting, go to the Analog Polarity Menu. From the Operating Menu select (SETUP/MORE.../SYSTEM/POLARTY). To change, use the function buttons to select either PIN2HOT or PIN3HOT, and press ENTER to activate. For additional information, see the Analog Polarity Menu on page 60.

## Setting Analog Input Attenuation

Analog input attenuation is set in 1 dB steps allowing a peak input signal level over the range of +24 dBu to +12 dBu to produce full scale digital record level. The Model Two is set at the factory to +18 dBu, which is a typical peak signal level (With an operating level of +4 dBu, and headroom of 14 dB, the peak level will be +18 dBu.). Analog input level attenuation is set by placing jumpers on pins located behind a cover panel on the Processor's rear panel, directly above the XLR analog input connectors. To access the jumpers, remove the two thumb screws holding the panel in place. The pins and jumpers are located as follows:

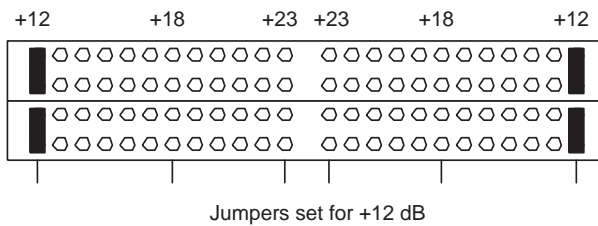

Jumpers set for +12 dB

The twelve pairs of pins on the left set Channel 1 and the twelve pairs of pins on the right set Channel 2. Placing the jumpers on the outermost pair of pins on each side provides maximum input sensitivity; a +12 dBu input signal will generate full scale record level. Each position inward of the jumpers produces 1 dB of attenuation. Placing the jumpers on the innermost pair of pins on each side produces 11 dB of attenuation, which will then require a +23 dBu input signal for full scale record level.

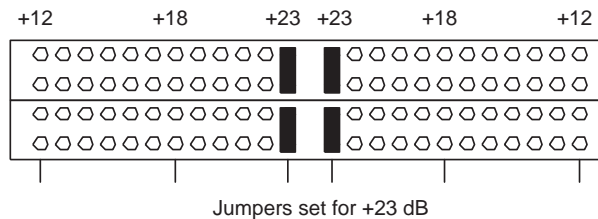

Jumpers set for +23 dB

If no jumpers are installed, 12 dB of attenuation is produced, requiring a +24 dBu input for full scale record level. The unused jumpers should be stored horizontally across two pins, as shown below, to keep them secure.

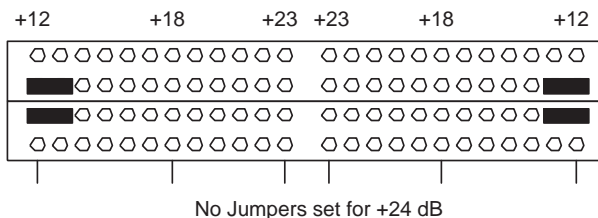

No Jumpers set for +24 dB

---

## Analog Connections

---

Analog Input and Output connections on the Model Two are balanced, using 3-pin XLR connectors with either pin 2 or 3 set as hot (software selectable) and pin 1 as ground. Input impedance is  $\geq 13 \text{ k}\Omega$  balanced ( $\geq 6.5 \text{ k}\Omega$  per leg); output impedance is  $20 \text{ }\Omega$  balanced ( $10 \text{ }\Omega$  per leg). If the audio source driving the Model Two is single ended, a balanced interconnect cable should be used with the return wire tied to ground at the sending end. If the audio output from the Model Two must drive an unbalanced load, use pin 2 as high, pin 1 as ground, and lift pin 3 at the load or use pin 3 as high, pin 1 as ground, and lift pin 2 at the load. **CAUTION: Never connect the unused low pin to ground, (pin 1) as that will short circuit one side of the Model Two's actively balanced, DC coupled, output amplifier, and seriously degrade performance.**

Analog audio connections and grounds should be isolated electrically and physically from digital signals, power conduits, and other noise sources. Audio cables should have low impedance grounds and one-hundred percent RF shielding. Cables using a foil shield and drain wire construction should not be used. They can produce voltages in the signal path due to ground currents flowing between different pieces of equipment.

---

## Analog Output Networks

---

HDCD Processor Analog Output Networks (AON's) are designed to improve the high frequency impedance match between the Model Two's D/A analog output impedance, which is about  $10 \text{ }\Omega$  per leg, and the characteristic impedance of typical analog audio cables, which is about  $60 \text{ }\Omega$ . The improved impedance match better terminates reflected high frequency energy in the cable, which can improve sonic clarity and purity. The AON's are designed to be connected between the Model Two's analog outputs, and the audio cables used to feed the monitoring system. Two AON's are provided with each Model Two.

Use of the AON's is optional. Depending on system variables, including the power bandwidth and type of monitor power amplifiers used, and the length of audio cables, the sound quality of the Model Two's D/A's may be preferred with or without the AON's. It is best to experiment by listening to a wide variety of different types of source material, both with and without the AON's installed. Note: The AON's should be used only with load impedances that are greater than  $4 \text{ k}\Omega$  balanced ( $2 \text{ k}\Omega$  per leg). The AON's are designed only for use with the Model Two. Use with other products is not recommended and may result in unsatisfactory performance.

---

## Digital Connections

---

The Digital Inputs and Outputs use 3-pin XLR connectors with pins 2 and 3 active, and pin 1 connected to chassis ground. Input and output impedances are  $110 \text{ }\Omega$  balanced. The signal format is AES3.

---

For best performance, AES3 cables should have the chassis ground path isolated by a series 100  $\Omega$  resistor. Use of a low capacitance isolation transformer at the Model Two's AES signal inputs, or the AES Signal Ground Isolator described below at both inputs and outputs is also recommended. Cables sending AES3 or synchronization signals from the Model Two to other equipment should have transformer isolation placed at the inputs of the receiving equipment. If external transformers are used they should always be at the receiving end of the digital signal path and never at the transmitting end.

The Word Clock Ref Input/Output uses a BNC connector with its shield isolated from chassis ground. An external 75  $\Omega$  terminating resistor must be used when Word Clock Ref is in input mode. This allows a high impedance loop-through connection. When configured as an output by selecting Reference Clock Master Mode (SETUP/INPUT/REFCLK/MASTER), the Word Clock Ref connector outputs a special AC coupled word clock. See pages 26 and 27 for more information. BNC word clock cables should **not** use low capacitance isolation transformers because they are unable to pass TTL level signals.

## AES Signal Ground Isolators

Pacific Microsonics AES Signal Ground Isolators are designed to break ground loops which can occur between the grounds of digital and analog signal cables when they are connected together by a single device that has both digital and analog signal connections, such as the Model Two HDCD Processor. If not properly isolated, noise currents on grounds have the potential to seriously degrade A to D and D to A converter performance.

The AES Signal Ground Isolators should be connected to all AES digital signal inputs and outputs at the Model Two whenever they are in use. The AES Isolators are designed to be used in series with standard AES cables that are connected to digital recorders, editing workstations, etc. Four Isolators are provided with each Model Two.

The AES Ground Isolators consist of a number of turns of precision 110  $\Omega$  balanced, shielded cable fed through multiple ferrite cores, each having a different selected permeability. The cable is terminated with XLR-3 connectors. This construction provides 160  $\mu$ H of inductive filtering effective over a very wide range of frequencies. A 100  $\Omega$  resistor is also placed in series with the pin 1 ground connection, providing further isolation.

Note: Pacific Microsonics recommends that as general practice, a 100  $\Omega$  resistor should be installed in series with the pin 1 (shield) connection at the female connector end of all AES cables to reduce the potential of digital ground loop noise.



## Model Two Processor Description

The Processor is contained in a 3 R.U. (5.25") high, 19" wide X 19.25" deep, rack mount enclosure with adjustable rear rack ears. The Processor contains the following subsystems: Analog to Digital Converter (ADC), Digital Signal Input/Output (DIO), Digital Signal Processor (DSP), Digital to Analog Converter (DAC), and Front Panel Controller (FPC). The ADC converts 2 channels of analog signals to digital at a sampling frequency of 192 kHz or 176.4 kHz. The DIO receives and transmits AES3 data, word clock, and RS-232 serial data. The DSP performs all HDCD encoding, decoding, frequency and word length conversion, digital signal gain changes, etc., employing eight Motorola 56009 Digital Signal Processors and one Pacific Microsonics PMD-100 HDCD Process Decoder ASIC. The DAC converts 2 channels of 24-bit to 16-bit digital data to analog signals. The FPC provides the interface between the DSP and the front panel graphic display, signal level meters, and controls.

All Processor controls, except the Analog Input Attenuator, are located on the front panel as shown below:

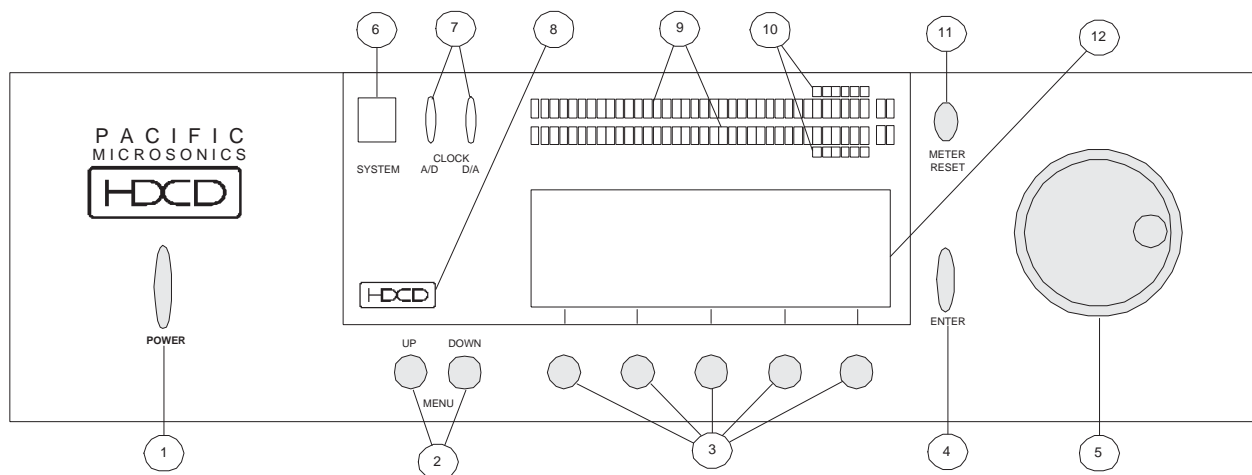

- |  |                          |
|--|--------------------------|
| 1 "POWER" Switch                       | 7 "CLOCK" Indicators     |
| 2 "MENU" "UP" and "DOWN" Buttons       | 8 "HDCD" Indicator       |
| 3 Function Buttons 1-5 (left to right) | 9 Signal Level Meters    |
| 4 "ENTER" Button                       | 10 Peak Extension Meters |
| 5 Rotary Control                       | 11 "METER RESET" Button  |
| 6 "SYSTEM" Status Indicator            | 12 Graphic Display       |

Processor rear panel I/O connections and Analog Input Attenuator.

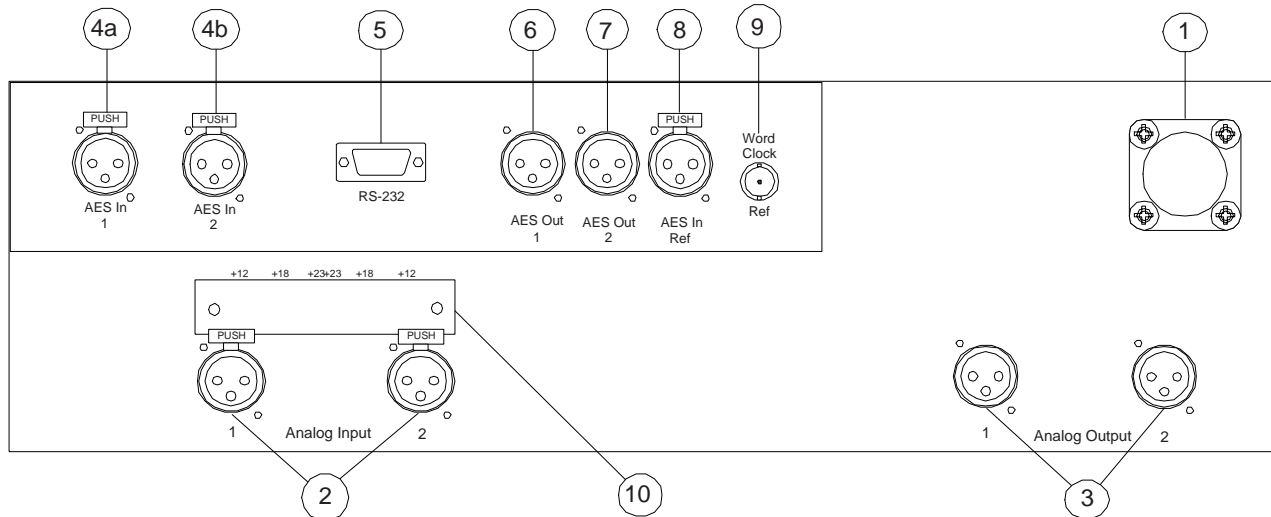

- |    |  |   |
|----|--|---|
| 1  | DC Power Input<br>(28-pin male)          | Connects to the DC Output on the Power Supply using the supplied DC power cable.  |
| 2  | Analog Input<br>(XLR balanced female)    | Left and right inputs accepting +12 to +24 dBu peak level analog signals. Pin polarity is selectable.   |
| 3  | Analog Output<br>(XLR balanced male)     | Left and right outputs producing up to +24 dBu peak level analog signals. Pin polarity is selectable.   |
| 4a | AES In 1<br>(XLR balanced female)        | Two or one channel AES3 format digital signal input.  |
| 4b | AES In 2<br>(XLR balanced female)        | Two or one channel AES3 format digital signal input active only in certain modes.   |
| 5  | RS-232<br>(D-Sub 9-Pin male)             | Serial data port for external computer loading of system software.  |
| 6  | AES Out 1<br>(XLR balanced male)         | Two or one channel AES3 format digital signal output.   |
| 7  | AES Out 2<br>(XLR balanced male)         | Two or one channel AES3 format digital signal output.   |
| 8  | AES In Ref<br>(XLR balanced female)      | AES3 format digital signal input used for external A/D clock sync reference.  |
| 9  | Word Clock Ref I/O<br>(BNC) Unterminated | Square wave, AC coupled, digital signal input/output used for word clock sync reference. Use as an input requires external 75 $\Omega$ termination. |
| 10 | Analog Input Attenuator                  | Access panel for jumper selectable analog input attenuator.   |

## Model Two Power Supply Description

The Power Supply is contained in a 14" wide X 2.5" high X 12.25" long enclosure and connects to the Processor using a 6 foot multiconductor DC power cable. To prevent ground loops from occurring between the AC power ground and audio signal ground, there is no ground connection between the Power Supply and the Processor. The Power Supply connects to a 100V to 240V, 50/60 Hz AC power source using a standard IEC grounded AC power cord. The rear panel connections on the Power Supply are as shown below:

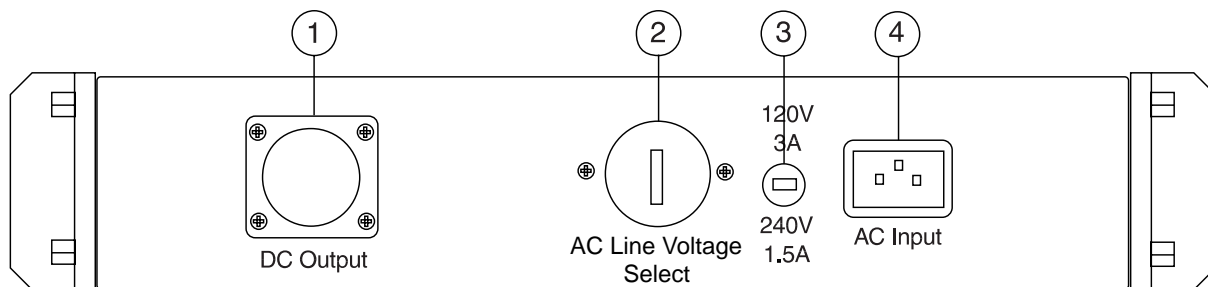

- |   |                                     |   |
|---|-------------------------------------|---|
| 1 | DC Output Connector (28-pin female) | Connects from the Power Supply to the DC Input on the Processor using the supplied DC power cable.  |
| 2 | AC Line Voltage Select              | Line voltage selection: 100V, 120V, 220V, 240V, AC, 50/60 Hz. (USA units are preset to 120V) AC input voltage must be within a + 5% to - 10% range of the selected voltage. |
| 3 | AC Power Fuse                       | Requires 3A (100V-120V) or 1.5A (220V-240V) 3AG fast blow fuse.   |
| 4 | AC Input Connector (IEC 3-pin male) | Connects to AC power outlet using grounded IEC AC power cord.   |

---

## Model Two Rev. 3.01 Software Features

---

1. Precision Master Word Clock Output capability in all AD and DD operating modes. This feature greatly reduces audible D/A conversion distortion caused by digital input signal time base jitter by allowing both the A/D and D/A converters to be clocked by the Model Two's precision internal clock. The Model Two can also generate or lock to either 1X or 2X reference clock frequencies in both AD and DD modes. See pages 26-27 for details.
2. Dual clock family operation at multiples of 44.1 kHz or 48 kHz, allowing A/D conversion, D/A conversion and digital processing at 192 kHz, 176.4 kHz, 96 kHz, 88.2 kHz, 48 kHz, and 44.1 kHz. Digital I/O is selectable between single wire, double speed, or dual wire, single speed AES at 88.2 kHz and 96 kHz. Input and output settings are independent.
3. HDCD for DVD-Audio, including automatic 24-bit, 20-bit, and 16-bit HDCD LSB code insertion at all sampling frequencies to allow HDCD process detection by HDCD equipped DVD-Audio playback equipment.
4. 44.1/48 kHz to 88.2/96 kHz and 176.4/192 kHz high resolution HDCD interpolation filtering to provide very high accuracy for both D/A conversion and high sample rate processing of 44.1/48 kHz signals.
5. HDCD Limiting, which is identical in function to Peak Extension, except that the limiting curve is not undone during HDCD decoded playback.
6. DAC-System Optimize, which allows the operation of the Model Two's D/A converters to be precisely optimized to the performance characteristics of the monitor electronics and power amplifier being used.

The Model Two has several new Operating Modes and Setup Menus to provide these capabilities. Descriptions of the Operating Modes and Menus are at the following locations:

### Setup and Operation

Operating Modes, pgs. 19-23  
Factory Preset Configurations, pgs. 24-25  
Using the Model Two as a Master System  
Word Clock Generator, pgs. 26-27  
Recording From an Analog Source pgs. 27-30  
Digital Post Production Processing, pgs. 30-32  
DAC-System Optimize, pg. 32  
HDCD Limiting, pg. 35  
HDCD 16-bit Dithers, pg. 37

### Reference

Menu Tree, pg. 40  
Second Operating Menu, pg. 41  
44.1/48 Base Sample Rate Menu pg. 45  
Operating Mode Menus, pg. 46  
Digital Output Format Menu, pg. 52  
Analog Input Menus, pgs. 52-56  
Digital Input Menus, pgs. 56-59  
DAC-System Optimize Menu, pg. 60

## Front Panel Controls and Displays

All Processor controls, except the Analog Input Attenuator, are located on the front panel shown below:

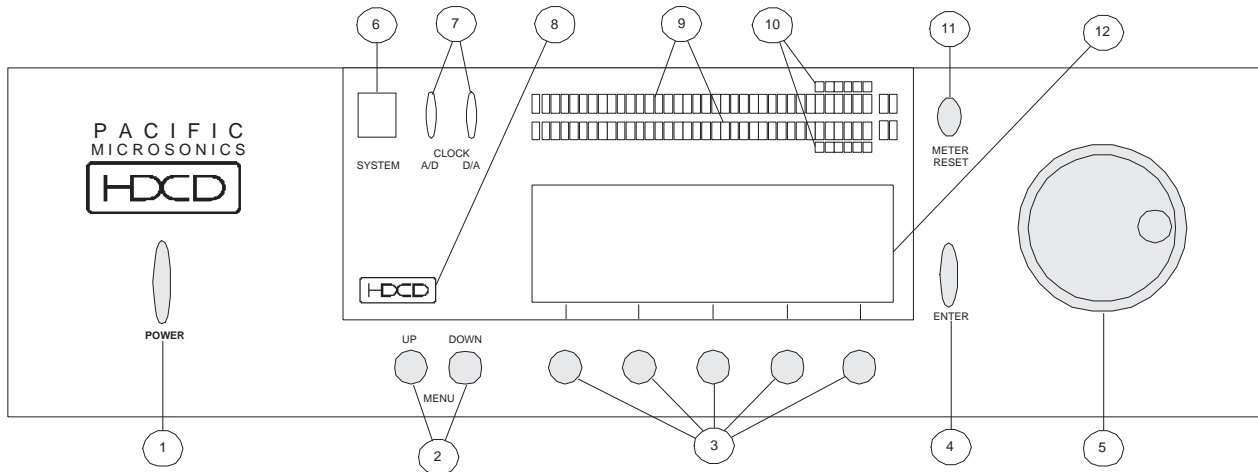

- |   |                                      |    |                       |
|---|--------------------------------------|----|-----------------------|
| 1 | "POWER" Switch                       | 7  | "CLOCK" Indicators    |
| 2 | "MENU" "UP" and "DOWN" Buttons       | 8  | "HDCD" Indicator      |
| 3 | Function Buttons 1-5 (left to right) | 9  | Signal Level Meters   |
| 4 | "ENTER" Button                       | 10 | Peak Extension Meters |
| 5 | Rotary Control                       | 11 | "METER RESET" Button  |
| 6 | "SYSTEM" Status Indicator            | 12 | Graphic Display       |

Processor control and display functions are described below.

Note: Menu selections, starting from the Operating Menu, to access a menu or feature are shown in (parentheses).

### Signal Level Meters

The Signal Level Meters consist of two, four color LED bar graphs which indicate program level for each channel. The LED ranges by color are shown below:

- Green =  $-\infty$  to -11 dB
- Yellow = -10 to -1 dB
- Amber = 0 dB
- Red = OVER

The range of -60 to -40dB is indicated in 5 dB steps, -40 to -20dB in 2 dB steps, and -20 to 0dB in 1 dB steps. OVER indication has two dedicated segments with individually ad-

justable parameters (see pages 59 and 60 in the Reference Section to set OVER indication parameters). Meter brightness is set in the Front Panel Display Menu (SETUP/MORE.../SYSTEM/PANEL).

## Meter Source

Meter signal sources are selected in the Operating Menu. The source options are: OUT\_1 (Digital Output 1), OUT\_2 (Digital Output 2), DIG\_IN (Digital Input 1), except AD+DD44 and AD+DD48 Operating Modes also have DIG\_IN2 (Digital Input 2). 88.2 kHz, 96 kHz, 176.4 kHz and 192 kHz Operating Modes have OUTPUT and DIG\_IN only.

## Meter Display Mode

Meter display mode options are selected in the Operating Menu. The options are NORMAL, FINE, and BITS.

**NORMAL** Shows the full dynamic range of the metered signal with a bar displaying average signal level and a separate pip, which normally floats above the bar, indicating peak level. A standard peak reading bar mode is also available by selecting PEAKBAR in the Meter Display Menu (SETUP/MORE.../METER).

Off	=	No Signal Present
Green	=	-∞ to -11 dB Signal
Yellow	=	-10 dB to -1 dB Signal
Amber	=	0 dB Signal
Red	=	Over Signal

**FINE** Displays average signal level at .2 dB per segment resolution, with the selected meter operating reference level indicated by the green to yellow LED transition point. Two adjacent LED segments are lit in fine mode, therefore exact reference level is indicated when both one green and one yellow segment are lit. Two lit green segments mean the level is low, and two lit yellow segments mean the level is high. The meter operating reference level is set in the Meter Setup Menu (SETUP/MORE.../METER).

**BITS** Displays bit activity of the digital audio word, indicating active word length. The MSB and bits 16, 20, and 24 are labeled on the bargraph.

## Peak Level Hold

Peak level hold modes are selectable in the Meter Setup Menu (SETUP/MORE.../METER). Peak level hold may be set to NONE, SHORT (1.5 seconds), LONG (4 seconds), or HOLD (until reset). The Meter Reset button clears held peak indications.

## Signal Over Segments

Each channel has two red Signal Over Segments labeled OVER. The threshold and hold characteristics of each segment are independently selectable using the Meter Overload Light Menus (SETUP/MORE.../METER/OVRLD\_1 or 2). The threshold for over segment #1 can be set for 1 to 4 consecutive over samples. The threshold for over segment #2 can be set for 0 to 3 consecutive over samples beyond the segment #1 setting. When hold is turned off, the over segment has the same hold parameters as the rest of the meter. When hold is turned on, the over segment is held until reset.

## Peak Extension/HDCD Limiting Meters

The Peak Extension/HDCD Limiting Meters are two rows of six red LEDs which indicate the 6 dB of extended range available when in HDCD Peak Extension or HDCD Limiting Mode. The meters are only active when monitoring HDCD 16-bit signals using Peak Extension or HDCD Limiting during recording, and signals with Peak Extension during playback. The six LED's illuminate from right to left, with each LED indicating 1dB of limiting. The full range of the Peak Extension/HDCD Limiting Meters will illuminate after the amber 0 dB LED's and before the red Over LED's on the Signal Level Meters.

For more information on Peak Extension and HDCD Limiting, see "Creating the 16-bit HDCD Release Sound You Want" on page 35 in this section and page 69 in the Reference section.

## Meter Reset Button

The Meter Reset Button is used to reset a held meter indication such as peak level or overload.

## Meter Setup

Meter setup functions, choices, and selection menu locations are as follows. For additional information see pages 41, 61 and 62 in the Reference section.

<u>Meter Function</u>	<u>Choices</u>	<u>Menu Location</u>
Mode	Normal, Fine, Bits	Operating
Source	Out 1, Out 2, Dig in 1, Dig in 2*	Operating
Display	Average/Peak or Peak	Meter Setup
Peak Level Hold	None, Short, Long, Hold	Meter Setup
Overload Light	Threshold Level, Hold On/Off	Meter Overload Light

\*Only in AD+DD44 and AD+DD48 Operating Modes

## Monitoring

In all Operating Modes, digital signal monitoring is available at the analog outputs. Monitor function setup choices are shown below. For more information see the Menu Descriptions in the Reference section, page 40.

<u>Monitor Function</u>	<u>Choices</u>	<u>Menu Locations</u>
Source	Folwmtr*, Out 1, Out 2, Dig In	Monitor Source
Level	Stereo, Ch 1, Ch 2, -78 to +24 dBu**	Levels
Phase	Normal, Invert	Monitor Setup
MONHD16 (HDCD 16-bit Amplitude Decoding)	Auto, On, Off	Mon.Set./Lvls/S.Op.
Gain Scaling	On, Off	Mon. Setup/S.Op.
Input HDCD Code Detect	24-BIT, 20-BIT, 16-BIT	Mon. Input HDCD Code Detect

\*Follow Meter

\*\* -11.9 to +24 dBu at 88.2, 96, 176.4 and 192 kHz

Note: It is recommended that the Monitor Output Level be set close to +18 dBu to provide the best combination of digital resolution and analog output stage performance.

## Power Switch

### **CAUTION: Follow instructions in the Installation section before switching power on.**

The Power Switch toggles between power on and power off. When the Model Two is off, pressing the Power Switch will turn the Processor and Power Supply units on. At power up all system settings remain as they were before power off. When the Model Two is on, pressing the Power Switch will call up the Power Off Menu:

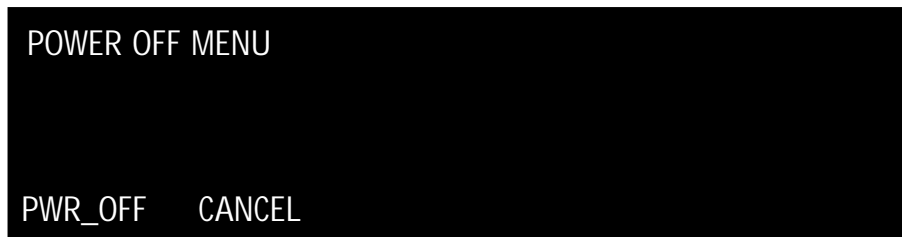

Pressing the button labeled (PWR\_OFF) will display the following prompt, "Power down HDCD unit? Press ENTER to confirm, or any other key to cancel". Press ENTER to turn off power, or press the button labeled (CANCEL), or any other button, to cancel.



---

## Graphic Display

---

The back lit Graphic Display has 7 lines of text with 40 characters per line. The display shows the current system operational, setup, and selection menus. Menu display formats are described in detail in the Reference section, page 39. Display contrast and brightness are adjustable using the Front Panel Display Menu. From the Operating Menu select (SETUP/MORE.../SYSTEM/PANEL).

---

## Menu Up and Down Buttons

---

These buttons are used to navigate up and down through the menu selections on the Graphic Display. Press "UP" once to move up to the previously displayed menu or "DOWN" to move down to the next menu in the current selection path. Pressing and holding "UP" will step up through each previously displayed menu until the top level Operating Menu is reached.

---

## Function Buttons

---

The five Function Buttons are used to select menu options shown on the Graphic Display. Each function button selects the menu item located directly above it on the display. Active menu items are displayed in

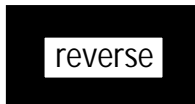

while selected items are



In some cases, a function button will operate as a toggle, selecting between multiple choices displayed above it on the Graphic Display.

---

## Enter Button

---

The Enter Button is used to activate selected (outlined) items on the Graphic Display. Once active, the item is displayed in reverse.

---

## Rotary Control

---

The Rotary Control is used to make changes to the values of selected (outlined) items on the Graphic Display. Changes to values become active immediately and may be canceled by pressing UNDO or saved by pressing ENTER. If the Levels Menu is exited with the Rotary Control active, it will remain active. Turning the Rotary Control one step in either direction will recall the Levels Menu with the Control still functioning.

---

## System Status Indicator

---

The System Status Indicator is a multi-color LED which shows system status. States displayed by the Indicator are shown below:

Off	=	System Off
Green	=	System Status Normal
Orange	=	Non Standard Operation
Red	=	Non Fatal Error
Flashing Red	=	Fatal Error

The most common causes of system errors involve system synchronization which will also extinguish one or more of the clock indicators. For example, a fatal error will result from no digital input source in digital input mode. Nonfatal errors may appear momentarily when switching from analog input to digital input mode or when changing meter or monitor sources. Nonstandard operation refers to certain setup configurations which are considered to be nonstandard operating conditions. For example, setup configurations such as 44.1 kHz A/D conversion and 88.2 kHz to 44.1 kHz sampling frequency conversion using fixed decimation filtering, and Software Download are considered nonstandard.

System Status Indicator, Clock Indicator, and HDCD Indicator brightness are adjusted by selecting STATUS in the Front Panel Display Menu (SETUP/MORE.../SYSTEM/PANEL).

---

## Clock Indicators

---

The Clock Indicators are two green LED's which indicate A/D and D/A clock status. Indications are as follows:

Green	=	Locked
Off	=	Not Locked

---

## HDCD Indicator

---

The HDCD Indicator consists of an LED back lit HDCD logo which lights when a 24-bit, 20-bit or 16-bit HDCD digital signal is detected. HDCD Indicator states are as follows:

Off	=	HDCD Code Not Detected
Blue	=	HDCD Code Detected.
Amber	=	HDCD 16-bit Code Detected with Monitor Amplitude Decoding Off.

Blue indicates HDCD code is detected. Amber indicates HDCD 16-bit code is detected and amplitude decoding at the monitor (D/A) output is turned off, or in a 44.1 kHz Digital Input Mode, there is an HDCD 16-bit input signal, and input amplitude decoding is turned off. HDCD 16-bit monitor amplitude decoding (MONHD16) can be turned on or off in the Levels Menu (LEVELS), the Second Operating Menu (OPS 2), or the Monitor Setup Menu (SETUP/MORE.../MONITOR). HDCD 16-bit input amplitude decoding can be turned on or off in the Digital Input HDCD\_16 Decoding Menu (SETUP/INPUT/HDCD\_IN).

## Operating Modes

The Model Two has thirteen Operating Modes that operate at either multiples of 44.1 kHz or multiples of 48 kHz, depending upon whether a base sample rate of 44.1\_X or 48\_X is selected in the 44.1/48 Base Sample Rate Menu.

**NOTE: The Operating Modes listed below and described on the following pages appear in the Operating Mode Menus if the 44.1 X base sample rate is selected. If 48 X is selected, the Operating Modes remain the same, except multiples of 48 replace 44.1.**

1. AD\_44.1 (44.1 kHz, 24, 20, and 16-bit A/D conversion, 16-bit amplitude encoding)
2. DD\_44-44 (44.1 kHz, 24, 20, and 16-bit word length conversion, level adjustment, HDCD 16-bit amplitude encoding and decoding)
3. AD+DD44 (AD\_44.1 A/D conversion cascaded with DD44-44 digital processing)
4. AD\_88.2 (88.2 kHz, 24, 20, and 16-bit A/D conversion)
5. DD88-44 (88.2 kHz to 44.1 kHz sampling frequency conversion, 24, 20, and 16-bit word length conversion, level adjust, and HDCD 16-bit amplitude encoding)
6. DD44-88 (44.1 kHz to 88.2 kHz sampling frequency conversion, 24, 20, and 16-bit word length conversion, level adjustment, and HDCD 16-bit amplitude decoding)
7. DD88-88 (88.2 kHz, 24, 20, and 16-bit word length conversion, level adjustment, and HDCD LSB code insertion)
8. AD176.4 (176.4 kHz, 24, 20, and 16-bit A/D conversion)
9. DD176.4 (176.4 kHz, 24, 20, and 16-bit word length conversion, level adjustment, and HDCD LSB code insertion)
10. DD176-88 (176.4 kHz to 88.2 kHz sampling frequency conversion, 24, 20, and 16-bit word length conversion, level adjust, and HDCD LSB code insertion)
11. DD176-44 (176.4 kHz to 44.1 kHz sampling frequency conversion, 24, 20, and 16-bit word length conversion, level adjust, and HDCD 16-bit amplitude encoding)
12. DD88-176 (88.2 kHz to 176.4 kHz sampling frequency conversion, 24, 20, and 16-bit word length conversion, level adjustment, and HDCD LSB code insertion)
13. DD44-176 (44.1 kHz to 176.4 kHz sampling frequency conversion, 24, 20, and 16-bit word length conversion, level adjustment, and HDCD 16-bit amplitude decoding)

44.1 kHz or 48 kHz base sample rates are selected in the 44.1/48 Base Sample Rate Menu (SETUP/MODE/44.1\_X or 48\_X).

Operating Modes are selected in the Operating Mode Menus (SETUP/MODE/MORE...). Each Operating Mode has specific features that are described below and shown in the Menu Tree on page 40. All metering functions and analog signal monitoring are available in all Operating Modes. Factory Presets that use an Operating Mode are listed at the end of the mode's description. Presets are selected in the Recall Presets Menu (SETUP/PRESETS).

**NOTE: HDCD LSB code must be reinserted when producing HDCD Compact Disc or DVD-Audio release masters if HDCD signal data has been altered in any way during digital post production processing. See Digital Post Production Processing on page 30.**

## AD\_44.1 Mode

In AD\_44.1 Mode, the Model Two performs 44.1 kHz A/D conversion with selectable HDCD 24-bit, 20-bit, or 16-bit output. Different word lengths may be independently fed to digital outputs 1 and 2 (SETUP/OUTPUT/OUT\_1 or OUT\_2). Between +3.15 dB and 0 dB of digital A/D gain adjustment in .05 dB steps is available using AD gain in the Levels Menu (LEVELS/AD\_GAIN). Factory Presets: AD1X-24, AD1X-16, AD1X2416.

## DD44-44 Mode

In DD44-44 Mode, the Model Two performs 44.1 kHz digital processing. 24-bit, 20-bit, 16-bit, or 16-bit HDCD input signals can be converted to 24-bit, 20-bit, or 16-bit HDCD word lengths, along with HDCD 16-bit amplitude encoding and decoding. Different word lengths may be independently fed to digital outputs 1 and 2 (SETUP/OUTPUT/OUT\_1 or OUT\_2). Between +6 and -25.9 dB (+12 to -19.9 dB if Peak Extend is used) of signal level adjustment is available using DSP gain in the Levels Menu (LEVELS/DSPGAIN). Factory Presets: DD1X-20, DD1X-16.

## AD+DD44 Mode

In AD+DD44 Mode, the Model Two combines AD\_44.1 and DD44-44 Modes, allowing their functions to be cascaded, saving considerable production time. For example, an analog input signal can be converted to a 24-bit HDCD signal on digital output 2, fed to a 24-bit processor or work station, returned to digital input 2, (which has an input word length of 24-bits and only functions at 44.1 kHz in AD+DD44 Mode) converted to a 16-bit HDCD signal on digital output 1, and fed to a 16-bit recorder, all in real time. Digital output 1 level can be adjusted relative to the level of digital output 2 over a range of +6 dB to -9.9 dB (+12 to -3.9 dB if Peak Extend is used) by using output 1 offset in the Levels Menu (LEVELS/OUT1OFS). Factory Preset: AD+DD1X.

## AD\_88.2 Mode

In AD\_88.2 Mode, the Model Two performs 88.2 kHz A/D conversion with selectable HDCD 24-bit, 20-bit, or 16-bit output. Selectable, two-wire, standard speed, or single wire, double speed AES signal formats are used for the 88.2 kHz stereo signal, and may be independently set on inputs and outputs (SETUP/INPUT or OUTPUT/FORMAT/1\_WIRE or 2\_WIRE). When two wire is selected, digital input and output 1 is channel 1, and digital input and output 2 is channel 2. When single wire is selected, digital input 1 and outputs 1 and 2 carry stereo signals. Digital A/D gain between 0 and +3.15 dB, in .05 dB steps, in the Levels Menu provides fine A/D level trim (LEVELS/AD\_GAIN). Factory Preset: AD2X-24.

## DD88-44 Mode

In DD88-44 Mode, the Model Two performs 88.2 kHz to 44.1 kHz sampling frequency conversion using HDCD adaptive decimation filtering. Fixed decimation filtering can also be used for special cases, such as some synthesized sources. The 44.1 kHz output word length is selectable between HDCD 24, 20, or 16-bit. Selectable, two-wire, standard speed, or single wire, double speed AES signal formats are used for the 88.2 kHz stereo input signal (SETUP/INPUT/FORMAT/1\_WIRE or 2\_WIRE). When two wire is selected, digital input 1 is channel 1, and digital input 2 is channel 2. When single wire is selected, digital input 1 is stereo. In DD88-44 Mode, only one word length can be selected for the 44.1 kHz output, which appears at both digital output 1 and digital output 2. Between +6 and -25.9 dB (+12 to -19.9 dB if Peak Extend is used) of signal level adjustment is available using DSP gain in the Levels Menu (LEVELS/DSPGAIN). Factory Presets: DD2X-24, DD2X-16.

## DD44-88 Mode

In DD44-88 Mode, the Model Two performs 44.1 kHz to 88.2 kHz sampling frequency conversion using advanced high resolution HDCD interpolation filtering. The 44.1 kHz input accepts 24-bit, 20-bit, 16-bit, or 16-bit HDCD signals, with HDCD 16-bit amplitude decoding and gain scaling available. The 88.2 kHz output word length is selectable between HDCD 24, 20, or 16-bit. Monitoring the 88.2 kHz output in DD44-88 Mode provides enhanced D/A conversion accuracy for 44.1 kHz signals, and is excellent for converting 44.1 kHz sources such as DAT's for analog processing during mastering. Selectable, two-wire, standard speed, or single wire, double speed AES signal formats are used for the 88.2 kHz stereo output signal (SETUP/OUTPUT/FORMAT/1\_WIRE or 2\_WIRE). When two wire is selected, digital output 1 is channel 1, and digital output 2 is channel 2. When single wire is selected, digital outputs 1 and 2 are stereo. Between +6 and -25.9 dB of signal level adjustment is available using DSP gain in the Levels Menu (LEVELS/DSPGAIN). Factory Preset: DD1X-2X.

## DD88-88 Mode

In DD88-88 Mode, the Model Two performs 88.2 kHz, 24-bit, 20-bit or 16-bit word length conversion, level adjustment using DSP gain, and reinsertion of HDCD LSB code. **Reinsertion of HDCD LSB code is necessary when producing HDCD DVD-Audio release masters if 88.2 kHz HDCD signals have their data altered during digital post production processing.** Selectable, two-wire, standard speed, or single wire, double speed AES signal formats are used for the 88.2 kHz stereo signal, and may be independently set on inputs and outputs (SETUP/INPUT or OUTPUT/FORMAT/1\_WIRE or 2\_WIRE). When two wire is selected, digital input and output 1 are channel 1, and digital input and output 2 are channel 2. When single wire is selected, digital input 1 and outputs 1 and 2 are stereo signals. Between +6 and -25.9 dB of signal level adjustment is available using DSP gain in the Levels Menu (LEVELS/DSPGAIN). Factory Preset: DD2X-2X.

## AD176.4 Mode

In AD176.4 Mode, the Model Two performs 176.4 kHz A/D conversion with selectable HDCD 24-bit, 20-bit, or 16-bit output. A two-wire, double speed AES signal format is used for the 176.4 kHz stereo signal. Digital output 1 is channel 1, and digital output 2 is channel 2. 0 to +3.15 dB of digital A/D gain adjustment in .05 dB steps is available using AD gain in the Levels Menu (LEVELS/AD\_GAIN). Factory Preset: AD4X-24.

## DD176.4 Mode

In DD176.4 Mode, the Model One performs 176.4 kHz, 24-bit, 20-bit and 16-bit word length conversion, level adjustment using DSP gain, and reinsertion of HDCD LSB code. **Reinsertion of HDCD LSB code is necessary when producing HDCD DVD-Audio release masters if 176.4 kHz HDCD signals have their data altered during digital post production processing.** A two-wire, double speed AES signal format is used for the 176.4 kHz stereo signal. Digital input and output 1 are channel 1, and digital input and output 2 are channel 2. Between +6 and -25.9 dB of signal level adjustment is available using DSP gain in the Levels Menu (LEVELS/DSPGAIN). Factory Preset: DD4X-4X.

## DD176-88 Mode

In DD176-88 Mode, the Model Two performs 176.4 kHz to 88.2 kHz sampling frequency conversion using HDCD decimation filtering. The 88.2 kHz output word length is selectable between HDCD 24-bit, 20-bit, or 16-bit. A two-wire, double speed AES signal format is used for the 176.4 kHz stereo input signal. Digital input 1 is channel 1, and digital input 2 is channel 2. Selectable, two-wire, standard speed, or single wire, double speed AES signal formats are used for the 88.2 kHz stereo output signal (SETUP/OUTPUT/FORMAT/1\_WIRE or 2\_WIRE). When two wire is selected, digital output 1 is channel 1, and digital output 2 is channel 2. When single wire is selected, digital outputs 1 and 2 are stereo. Between +6 and -25.9 dB of signal level adjustment is available using DSP gain in the Levels Menu (LEVELS/DSPGAIN). Factory Preset: DD4X-2X.

## DD176-44 Mode

In DD176-44 Mode, the Model Two performs 176 kHz to 44.1 kHz sampling frequency conversion using HDCD adaptive decimation filtering. Fixed decimation filtering can also be used for special cases, such as synthesized sources. The 44.1 kHz output word length is selectable HDCD 24, 20, or 16-bit. A two-wire, double speed AES signal format is used for the 176.4 kHz stereo input signal. Digital input 1 is channel 1, and digital input 2 is channel 2. In DD176-44 Mode, only one word length can be selected for the 44.1 kHz output, which appears at both digital output 1 and digital output 2. Between +6 and -25.9 dB (+12 to -19.9 dB if Peak Extend is used) of signal level adjustment is available using DSP gain in the Levels Menu (LEVELS/DSPGAIN). Factory Presets: DD4X-24, DD4X-16.

## DD88-176 Mode

In DD88-176 Mode, the Model Two performs 88.2 kHz to 176.4 kHz sampling frequency conversion using high resolution HDCD interpolation filtering. Selectable, two-wire, standard speed, or single wire, double speed AES signal formats are used for the 88.2 kHz stereo input signal (SETUP/INPUT/FORMAT/1\_WIRE or 2\_WIRE). When two wire is selected, digital input 1 is channel 1, and digital input 2 is channel 2. The 176.4 kHz output word length is selectable between HDCD 24, 20, or 16-bit. A two-wire, double speed AES signal format is used for the 176.4 kHz stereo output signal. Digital output 1 is channel 1, and digital output 2 is channel 2. Between +6 and -25.9 dB of signal level adjustment is available using DSP gain in the Levels Menu (LEVELS/DSPGAIN). Factory Preset: DD2X-4X.

## DD44-176 Mode

In DD44-176 Mode, the Model Two performs 44.1 kHz to 176.4 kHz sampling frequency conversion using high resolution HDCD interpolation filtering. The 44.1 kHz input accepts 24-bit, 20-bit, 16-bit, or 16-bit HDCD signals, with HDCD 16-bit amplitude decoding and gain scaling available. The 176.4 kHz output word length is selectable between HDCD 24, 20, or 16-bit. Monitoring the 176.4 kHz output in DD44-176 Mode provides greatly enhanced D/A conversion accuracy for 44.1 kHz signals, and is excellent for converting 44.1 kHz sources such as DAT's for analog processing during mastering. The 176.4 kHz output word length is selectable between HDCD 24, 20, or 16-bit. A two-wire, double speed AES signal format is used for the 176.4 kHz stereo output signal. Digital output 1 is channel 1, and digital output 2 is channel 2. Between +6 and -25.9 dB of signal level adjustment is available using DSP gain in the Levels Menu (LEVELS/DSPGAIN). Factory Preset: DD1X-4X.

**CAUTION: If a standard STEREO 44.1 kHz AES signal is connected to either of the digital inputs when the Model Two is set up for AES two wire input in AD 88.2, DD88-44, DD88-88 or DD88-176 Modes, supersonic spurious energy will appear at the D/A converter analog outputs which may damage loudspeakers.**

**CAUTION: Whenever a 24-bit output word length is selected, it is essential to verify that the equipment the signal is fed to will pass or process a 24-bit signal without truncation. When in doubt, it is better to select a 20-bit output word length. An intact 20-bit signal will sound better than a truncated 24-bit signal.**

Output word length is set in the Digital Output 1 and 2 Menus (SETUP/OUTPUT/OUT\_1 or OUT\_2).

**NOTE: When multiple Model Twos are used for multichannel A/D conversion, the A/D reference clocks must be locked together. See Page 53 for set up information.**

## Presets

---

The Model Two stores and recalls virtually all system setup parameters in labeled presets. The preset use functions are shown below. For more information on using and storing presets see pages 59, 63 and 64. Eighteen factory configured presets are installed.

### Preset Function

Recall  
Store/Rename/Erase

### Menu Location

Recall Presets(SETUP/PRESETS)  
Store Presets(SETUP/MORE.../STORE\_P)

The factory installed presets are: AD1X-24, AD1X-16, AD1X2416, AD+DD1X, DD1X-20, DD1X-16, DD1X-2X, DD1X-4X, AD2X-24, DD2X-2X, DD2X-24, DD2X-16, DD2X-4X, AD4X-24, DD4X-4X, DD4X-2X, DD4X-24, DD4X-16. The setup values stored in the factory presets are listed below.

**NOTE: The preset setup values shown below appear if the 44.1 X base sample rate is selected. If the 48 X base sample rate is selected, the setup values remain the same, except multiples of 48 appear in place of multiples of 44.1.**

## Factory Preset Configurations

---

NOTE: The following setup values are the same for all factory presets:

Menu/FUNCTION:	VALUE:
Operating/MTRMODE	NORMAL
Operating/MTRSRCE	OUT_1 (44.1 kHz output) OUTPUT (88.2/176.4 kHz output)
Second Operating/PEAKEXT	OFF
Second Operating/LOWLVL	OFF
Monitor Source	FOLWMTR
Levels/AD_GAIN or DSPGAIN	0.0
Levels/MONLVL	+18.0
Digital Output Phase Invert	NORMAL
Digital Output HDCD Setup/PEAKEXT	OFF
Digital Output HDCD Setup/LOWLVL	OFF
Monitor Setup/PHASE	NORMAL
Monitor Setup/HDCD	AUTO
Monitor Setup/SCALING	OFF
Meter Setup/PEAKHLD	NONE
Meter Over #1/THRSHLD	1
Meter Over #1/HOLD	OFF
Meter Over #2/THRSHLD	3
Meter Over #2/HOLD	ON
Meter Setup/FINEREF	-14



## Factory Preset Configurations

(Suffixed values are shown only if they are different from those of the first preset listed in a column.)

	PRESETS:			
	AD1X-24	AD+DD1X	AD2X-24	DD2X-24
	AD1X-16*	DD1X-20*	DD1X-2X*	DD2X-16*
	AD1X2416+	DD1X-16+	DD1X-4X**	DD4X-24+
			DD2X-2X+	DD4X-16^
			DD2X-4X++	
			AD4X-24^	
			DD4X-4X^^	
			DD4X-2X-	
Menu/FUNCTION:	VALUES:			
Operating Mode	AD_44.1	AD+DD44	AD_88.2	DD88-44
		DD44-44*+	DD44-88*	DD176-44+^
			DD44-176**	
			DD88-88+	
			DD88-176++	
			AD176.4^	
			DD176.4^^	
			DD176-88-	
Digital Output 1 Word Length	HDCD_24	HDCD_16	HDCD_24	HDCD_24
	HDCD_16*+	HDCD_20*		HDCD_16*+
Output 1 HDCD_16 Dither	DITHER1*+	DITHER1	_____	DITHER1*+
Digital Output 2 Word Length	HDCD_24	HDCD_24	_____	HDCD_24
	HDCD_16*	HDCD_20*		HDCD_16+^
		HDCD_16+		
Output 2 HDCD_16 Dither	DITHER1*	DITHER1	_____	DITHER1+^
Digital Output Format	_____	_____	2_WIRE	_____
A/D Reference Clock	INTERN	INTERN	INTERN	_____
A/D Filter Mode	NORMAL	NORMAL	_____	_____
Monitor Input HDCD Code Detect	24-BIT	20-BIT*	24-BIT	_____
	16-BIT*+	16-BIT+	16-BIT**(**)	
Monitor Reference Clock	DIG_IN	DIG_IN	DIG_IN	_____
External Reference Clock Frequency	1X_REF	1X_REF	1X_REF	1X_REF
Monitor Digital Input Format	_____	_____	2_WIRE	_____
Digital Input HDCD Code Detect	_____	24-BIT	24-BIT	24-BIT
Dig. In. HDCD_16 Decoding/DCODE16	_____	OFF	ON**(**)	_____
Dig. In. HDCD_16 Decoding/SCALING	_____	OFF	OFF	_____
2X To 1X Filter Mode	_____	_____	_____	NORMAL
Digital In Reference Clock	_____	DIG_IN*+	DIG_IN	DIG_IN
Digital Input Format	_____	_____	2_WIRE	2_WIRE

**NOTE:** All set-up values are stored in Presets except for System Menu PANEL, POLARITY and DAC\_OPT values, and Meter Setup Menu DISPLAY values.

---

## Using the Model Two as a Master Word Clock Generator

---

In all AD and DD operating modes at all sampling rates, the Model Two can be configured to be a master word clock generator. This mode of operation is highly recommended because it allows the Model Two's A/D and D/A converters to be clocked directly by the Model Two's precision internal clock, instead of by the digital input signal, when the devices that are connected to the Model Two's digital signal inputs and outputs, such as recorders, transports, DAW's, etc. are locked to the Model Two's word clock output. This greatly reduces D/A conversion distortion caused by digital input signal time base jitter. Of course, a D/A converter can only be locked to a clock separate from the digital signal being monitored if the clock is synchronous with the signal!

### Setup for AD and DD Operating Modes

#### For AD Operating Modes:

1. From the Operating Menu, select the desired Base Sample Rate (SETUP/MODE/44.1\_X or 48\_X) and Preset Configuration (SETUP/PRESETS).
2. From the Operating Menu, select (SETUP/INPUT/REFCLK/MASTER).
3. From the Operating Menu, select (SETUP/INPUT/MON\_REF/A/D\_REF).
4. Connect a 75  $\Omega$  coaxial cable from the Model Two's Word Clock Ref BNC connector to the 75  $\Omega$  external word clock or word sync input BNC connector on the component connected to the Model Two's digital signal inputs and outputs, or to a 75  $\Omega$  word clock distribution amplifier.

#### For DD Operating Modes:

1. From the Operating Menu, select the desired Base Sample Rate (SETUP/MODE/44.1\_X or 48\_X) and Preset Configuration (SETUP/PRESETS).
2. From the Operating Menu, select (SETUP/INPUT/REF\_CLK/MASTER).
3. Connect a 75  $\Omega$  coaxial cable from the Model Two's Word Clock Ref BNC connector to the 75  $\Omega$  external word clock or word sync input BNC connector on the component connected to the Model Two's digital signal inputs and outputs, or to a 75  $\Omega$  word clock distribution amplifier.

#### Setup for AD and DD Multichannel Operation:

One Model Two is configured as described above to be the master word clock generator. Additional Model Twos are configured to be "slaves" as described on page 27. Their Word Clock Ref BNC connectors automatically switch to become high impedance inputs and the 75  $\Omega$  word clock output of the master Model Two is looped through them using the supplied 75  $\Omega$  coaxial BNC cables and BNC "T" connectors and is then terminated by the 75  $\Omega$  word clock or word sync input of the device connected to the Model Twos' digital signal inputs and outputs or by a 75  $\Omega$  word clock distribution amplifier.

## For AD Operating Modes Multichannel "Slave":

1. From the Operating Menu, select the desired Base Sample Rate (SETUP/MODE/44.1\_X or 48\_X) and Preset Configuration (SETUP/PRESETS).
2. From the Operating Menu, select (SETUP/INPUT/REFCLK/REFWCLK).
3. From the Operating Menu, select (SETUP/INPUT/MON\_REF/A/D\_REF).

## For DD Operating Modes Multichannel "Slave":

1. From the Operating Menu, select the desired Base Sample Rate (SETUP/MODE/44.1\_X or 48\_X) and Preset Configuration (SETUP/PRESETS).
2. From the Operating Menu, select (SETUP/INPUT/REF\_CLK/REFWCLK).

In 2X and 4X sampling rate AD and DD operating modes, the reference clock frequency can be set to 1X or 2X. From the Operating Menu, select (SETUP/INPUT/REF\_FRQ/1X\_REF or 2X\_REF). **NOTE: If a 2X reference clock is used when a 1X input or output data rate is selected, there can be an output phase ambiguity between multiple Model Twos locked to the same clock. All factory presets have a default 1X clock frequency.**

**NOTE:** The Model Two's word clock output is a floating signal with positive and negative voltage potentials. This is done to avoid ground loops between multiple Model Twos used for multichannel A/D conversion. The floating signal is compatible with most CMOS "TTL compatible" 75  $\Omega$  word clock inputs found on modern equipment. A "true" TTL clock input will draw more current, which may reduce the signal amplitude to below safe TTL trigger levels. An AC coupled CMOS input word clock distribution amplifier with a ground referenced TTL compatible output can be used to buffer the signal if necessary.

## Recording From an Analog Source

When performing 24-bit or 20-bit A/D conversion, setting peak signal levels within 2 dB of full scale is sufficient. Since the Model Two's 24-bit or 20-bit resolution is so much greater than 16-bit, it is not necessary to risk signal "overs" by pushing the level to full scale. Peak signal levels can be transparently increased later using DSP Gain.

A warm up time of at least 30 minutes is recommended prior to A/D conversion or critical D/A monitoring. The Model Two should be set to an A/D mode during warm up, which exercises the A/D converters with dither. A/D conversion can be clocked by either the Model Two's internal clock or an external reference.

## Setup for 44.1/48 kHz, 88.2/96 kHz or 176.4/192 kHz A to D Conversion

In all A/D Modes, the Model Two converts analog signals into HDCD 24-bit, 20-bit, or 16-bit signals. Either 44.1 kHz or 48 kHz clock families are selected in the 44.1/48 Base Rate Sample Rate Menu (SETUP/MODE/44.1\_X or 48\_X).

## For 44.1 kHz or 48 kHz A/D conversion:

1. Connect an analog signal source to the channel 1 and 2 analog inputs.
2. From the Operating Menu, select (SETUP/MODE/44.1\_X or 48\_X)
3. Connect AES Out 1 or 2 to the AES input of a 44.1/48 kHz digital audio recorder.
4. Connect the AES output of the digital audio recorder to AES In 1.
5. From the Operating Menu, select (SETUP/PRESETS) and select preset AD1X-24 or AD1X-16 depending on the desired output word length.

```
RECALL PRESETS MENU X=44.1 SAMPLE RATE
AD1X-24 DD1X-20 DD2X-2X DD4X-4X
AD1X-16 DD1X-16 DD2X-24 DD4X-2X
AD1X2416 DD1X-2X DD2X-16 DD4X-16
AA+DD1X AD2X-24 AD4X-24 MORE...
FIXED: ANALOG to 1X HDCD24
RECALL
```

6. Or, from the Operating Menu, select (SETUP/MODE/MORE.../AD\_44.1).
7. From the Operating Menu, select (SETUP/OUTPUT/OUT\_1), then select the digital output word length. HDCD\_24 is selected by preset AD1X-24.
8. From the Operating Menu, select (SETUP/INPUT/HDCDBIT), then select the monitor input HDCD code detect word length to match the digital output word length.

## For 88.2 kHz or 96 kHz A/D conversion:

1. Connect an analog signal source to the channel 1 and 2 analog inputs.
2. From the Operating Menu, select (SETUP/MODE/44.1\_X or 48\_X)
3. From the Operating Menu, select (SETUP/PRESETS) and select preset AD2X-24.
4. Or, from the Operating Menu, select (SETUP/MODE/MORE.../MORE.../AD\_88.2 or 96).
5. From the Operating Menu, select (SETUP/OUTPUT/OUTPUT), then select the digital output word length. HDCD\_24 is selected by preset AD2X-24.
6. From the Operating Menu, select (SETUP/OUTPUT/FORMAT), then select the digital output format. 1\_WIRE selects single wire, double speed AES. 2\_WIRE selects two wire, single speed AES.
7. If single wire was selected, connect AES Out 1 or AES Out 2 to the double speed AES input of a digital recorder or Digital Audio Workstation. Connect the double speed AES output of the digital recorder or DAW to AES In 1.
8. If two wire was selected, connect AES Out 1 to a 4 channel, 24-bit or 20-bit, 44.1/48 kHz digital audio recorder's channel 1 and 2 AES input, and AES Out 2 to the recorder's channel 3 and 4 AES input. Or connect AES Out 1 and 2 to the AES two wire inputs of an 88.2/96 kHz digital recorder or DAW. Connect the channel 1 and 2 AES output of the 44.1/48 kHz digital audio recorder to AES In 1, and channels 3 and 4 to AES In 2. Or connect the two wire outputs of the 88.2/96 kHz recorder or DAW to AES In 1 and 2.

## For 176.4 kHz or 192 kHz A/D conversion:

1. Connect an analog signal source to the channel 1 and 2 analog inputs.
2. From the Operating Menu, select (SETUP/MODE/44.1\_X or 48\_X)
3. Connect AES Out 1 and 2 to double speed AES inputs 1 and 2 of a 176.4/192 kHz digital audio recorder or DAW.
4. Connect the double speed AES 1 and 2 output of the digital audio recorder or DAW to AES In 1 and 2.
5. From the Operating Menu, select (SETUP/PRESETS) and select preset AD4X-24.
6. Or, from the Operating Menu, select (SETUP/MODE/MORE.../MORE.../MORE.../AD\_176.4 or 192).
6. From the Operating Menu, select (SETUP/OUTPUT/OUT\_1), then select the digital output word length. HDCD\_24 is selected by preset AD1X-24.
7. From the Operating Menu, select (SETUP/INPUT/HDCDBIT), then select the monitor input HDCD code detect word length to match the digital output word length.

Once the Model Two is set up for A/D conversion, other parameters such as Reference Clock (SETUP/INPUT/REFCLK), Digital Output Word Length (SETUP/OUTPUT/OUT\_1 or OUT\_2), Peak Extend, etc. can be changed as desired. For more information refer to pages 47 through 55 in the Reference section.

For more detailed A/D operating techniques, see "A/D Conversion of Analog Tape Recordings" on page 34.

## Setup for 44.1/48 kHz A to D Conversion With Simultaneous D to D Processing

In AD+DD44 or DD+AD48 Modes, the Model Two converts analog signals to HDCD 44.1/48 kHz, 24-bit or 20-bit signals, and can simultaneously convert 44.1/48 kHz, 24-bit or 20-bit digital signals, with digital signal level control, to HDCD 16-bit signals. AD+DD44/48 mode thus allows cascading 24-bit or 20-bit HDCD A/D conversion with 24-bit or 20-bit digital processing and conversion to a 16-bit HDCD signal, in real time for Compact Disc release mastering.

## Setup for AD+DD44 or AD+DD48 mode:

1. Connect an analog signal source to the channel 1 and 2 analog inputs.
2. From the Operating Menu, select (SETUP/MODE/44.1\_X or 48\_X)
3. Connect AES Out 2 to a 20 or 24-bit DAW or digital processor.
4. Connect the 20 or 24-bit output of the DAW or processor to AES In 2.
5. Connect AES Out 1 to a 16-bit master recorder. The master recorder's 16-bit output may be connected to AES In 1 for confidence monitoring.
6. From the Operating Menu, select (SETUP/PRESETS) and select preset AD+DD1X.
7. Or, from the Operating Menu, select (SETUP/MODE/MORE.../AD+DD44 or AD+DD48).

8. From the Operating Menu, select (SETUP/OUTPUT/OUT\_2). Then select the digital output 2 word length. HDCD\_24 is selected by preset AD+DD1X.
9. In the Digital Output 1 Word Length Menu (OUT\_1), select the digital output 1 word length. HDCD\_16 is selected by preset AD+DD1X.

## Digital Post Production Processing

The Model Two's post production processing capabilities include converting signal word lengths using HDCD dither and optional 16-bit amplitude encoding, decimating 176.4/192 kHz signals to 88.2/96 kHz or 44.1/48 kHz and decimating 88.2/96 kHz signals to 44.1/48 kHz using HDCD dynamic decimation filtering, interpolating 44.1/48 kHz signals to 88.2/96 kHz or 176.4/192 kHz and interpolating 88.2/96 kHz signals to 176.4/192 kHz using HDCD high resolution interpolation filtering and adjusting digital signal level using low distortion HDCD DSP Gain. The Model Two converts word lengths between 24-bits, 20-bits, and 16-bits at all of its sampling rates. The Model Two interfaces with a wide variety of digital audio recorders and editing workstations. **NOTE: The bit structure of HDCD signals may not be altered without losing the HDCD LSB code. If digital processing that loses the code is performed on HDCD 24-bit recordings intended for 24-bit DVD format release, the LSB code must be reinserted by passing the signal through the Model Two set up in the same 24-bit D to D mode. To perform digital processing of HDCD 16-bit amplitude encoded (using Peak Extend or Low Level Extend) recordings, the Model Two must first be used to decode them to 24-bit or 20-bit signals prior to processing, and then is used to encode them back to HDCD 16-bit after processing.**

### Setup for 44.1 kHz Word Length Conversion & HDCD 16-bit Encoding

In DD44-44 Mode, the Model Two converts 44.1 kHz digital signals from longer word lengths to HDCD 16-bit using selectable HDCD dither and optional amplitude encoding. It also converts HDCD 16-bit signals to 24-bit or 20-bit word lengths.

1. From the Operating Menu, select (SETUP/MODE/44.1\_X)
2. Connect a 24-bit or 20-bit 44.1 kHz digital source to the AES 1 Input.
3. Connect AES Output 1 or 2 to a digital audio recorder or DAW.
4. From the Operating Menu, select (SETUP/PRESETS) and select preset DD1X-16.
5. Or, from the Operating Menu select (SETUP/MODE/MORE.../DD44-44).

Once the Model Two is set up for digital word length conversion, other parameters such as Digital Input Word Length, Digital Output Word Length, Digital Output HDCD Setup, etc. may be changed as desired. See pages 47-58 in the Reference section.

### Setup for 88.2/96 kHz to 44.1/48 kHz Decimation & Word Length Conversion

In DD88-44 or DD96-48 Modes, the Model Two converts 24-bit or 20-bit, 88.2/96 kHz

digital signals to HDCD 24, 20 or 16-bit, 44.1/48 kHz signals using HDCD decimation.

1. From the Operating Menu, select (SETUP/MODE/44.1\_X or 48\_X).
2. From the Operating Menu, select (SETUP/PRESETS) and select either preset DD2X-24 or DD2X-16, depending on the desired output word length.
3. Or, from the Operating Menu, select (SETUP/MODE/MORE.../MORE.../DD88-44 or DD96-48).
4. From the Operating Menu, select (SETUP/INPUT/FORMAT), then select the digital input format. 1\_WIRE selects single wire, double speed AES. 2\_WIRE selects two wire, single speed AES. The factory presets select two wire, single speed AES input.
5. If two wire was selected, connect the AES channel 1 and 2 output of a 4 channel, 24-bit or 20-bit, 44.1/48kHz digital audio recorder to AES In 1, and the AES channel 3 and 4 output to AES In 2, or connect the AES two wire 88.2/96 kHz outputs of a DAW to AES In 1 and 2.
6. If single wire was selected, connect the double speed AES output of an 88.2/96 kHz digital recorder or DAW to AES In 1.
7. Connect AES Output 1 or 2 to a digital audio recorder or DAW.

**CAUTION: Do not feed a standard STEREO 44.1 kHz or 48 kHz AES signal to either AES In 1 or 2 when the Model Two is set up for AES two wire input in DD88-44 or DD96-48 Modes. Doing so will cause supersonic spurious energy to appear at the D/A analog outputs which may damage loudspeakers.**

## Setup for 44.1/48 kHz to 88.2/96 kHz Interpolation & Word Length Conversion

In DD44-88 or DD48-96 Modes, the Model Two converts 24-bit, 20-bit, or 16-bit, 44.1/48 kHz signals to HDCD 24-bit, 20-bit or 16-bit 88.2/96 kHz signals using high resolution HDCD interpolation filtering.

1. From the Operating Menu, select (SETUP/MODE/44.1\_X or 48\_X)
2. From the Operating Menu, select (SETUP/PRESETS) and select preset DD1X-2X.
3. Or, from the Operating Menu, select (SETUP/MODE/MORE.../MORE.../DD44-88 or DD48-96).
4. Connect a 24-bit, 20-bit, or 16-bit 44.1/48 kHz digital source to the AES 1 Input.
5. From the Operating Menu, select (SETUP/OUTPUT/FORMAT), then select the digital output format. 1\_WIRE selects single wire, double speed AES. 2\_WIRE selects two wire, single speed AES. The factory presets are two wire, single speed AES output.
6. If single wire was selected, connect AES Out 1 or AES Out 2 to the double speed AES input of an 88.2/96 kHz digital recorder or DAW.
7. If two wire was selected, connect AES Out 1 and 2 to the AES single speed, two wire inputs of an 88.2/96 kHz digital recorder or DAW.

Once the Model Two is set up for 44.1/48 kHz to 88.2/96 kHz interpolation, other parameters such as Digital Input HDCD Code Detect, Digital Input HDCD\_16 Decoding, Digital Output Word Length, etc. may be changed as desired. For information, see pages 46-56.

## Setup for 176.4/192 kHz to 44.1/48 kHz Decimation & Word Length Conversion

In DD176-44 or DD192-48 Modes, the Model Two converts 24-bit or 20-bit, 176/192 kHz digital signals to HDCD 24-bit, 24-bit, or 16-bit, 44.1/48 kHz signals using HDCD adaptive filter decimation.

1. From the Operating Menu, select (SETUP/MODE/44.1\_X or 48\_X)
2. Connect AES In 1 and 2 to the double speed AES outputs 1 and 2 of a 176.4/192 kHz digital audio recorder or DAW.
3. Connect AES Output 1 or 2 to a digital audio recorder or DAW.
4. From the Operating Menu, select (SETUP/PRESETS) and select either preset DD4X-24 or DD4X-16, depending on the desired output word length.
5. Or, from the Operating Menu, select (SETUP/MODE/MORE.../MORE.../MORE.../DD176-44 or DD192-48).
6. From the Operating Menu, select (SETUP/OUTPUT/OUT\_1), and select the word length.

## Setup for 44.1/48 kHz to 176.4/192 kHz Interpolation & Word Length Conversion

In DD44-176 or DD48-192 Modes, the Model Two converts 24-bit, 20-bit, or 16-bit, 44.1/48 kHz signals to HDCD 24-bit, 20-bit or 16-bit 176/192 kHz signals using high resolution HDCD interpolation filtering.

1. From the Operating Menu, select (SETUP/MODE/44.1\_X or 48\_X)
2. Connect a 24-bit, 20-bit, or 16-bit 44.1/48 kHz digital source to the AES 1 Input.
3. Connect AES Out 1 and 2 to the AES double speed, two wire inputs of a 176/192kHz digital recorder or DAW.
4. From the Operating Menu, select (SETUP/PRESETS) and select preset DD1X-4X.
5. Or, from the Operating Menu, select (SETUP/MODE/MORE.../MORE.../MORE.../MORE.../DD44-176 or DD48-192).

Once the Model Two is set up for 44.1/48 kHz to 176.4/192 kHz interpolation, other parameters such as Digital Input HDCD Code Detect, Digital Input HDCD\_16 Decoding, Digital Output Word Length, etc. may be changed as desired. For more information, see pages 47-58.

## DAC-Monitoring System Performance Optimization

The Model Two has advanced DAC optimization capabilities designed to provide the highest possible fidelity with different types of monitoring electronics and power amplifiers. Specific DAC dithers are provided for 44.1/48 kHz (1X) and 88.2/96/176.4/192 kHz (2X/



4X) signals. While DAC dither greatly improves the linearity of D/A conversion, it also adds supersonic energy to the analog output signal, which will interact differently with various types of line amplifiers and power amplifiers. Higher levels of dither generally improve DAC linearity, but also can stress electronics that have limited high frequency slewing capabilities. This can manifest as audible Transient Intermodulation Distortion, or a smearing of detail. To allow the best possible match of dither to amplifier performance, three selectable dither levels are provided for 1X conversion, and four levels are provided for 2X and 4X conversion.

The best way to determine the optimum DAC dither for a specific monitoring system is by listening to various types of source material while selecting different DAC dither curves. Optimum settings should be determined separately for 1X and 2X/4X material. Generally, the "wider-band" or "faster" the monitoring electronics, the higher the optimum dither level will be. The factory preset dither level is P0 (preset 0) with M6 and M12 (minus 6 dB and 12 dB) options available at 1X, and M3, M6 and P3 (minus 3 dB, minus 6 dB and plus 3 dB) options available at 2X/4X. DAC dither levels are set in the DAC-System Optimize Menu (SETUP/MORE.../SYSTEM/DAC\_OPT). Changing Presets does not change DAC dither settings.

## **Compact Disc Release Mastering**

The Model Two produces HDCD 16-bit, 44.1 kHz, Compact Disc release masters from both analog sources or longer word length digital sources. If a digital source wasn't made using HDCD A/D conversion, its dynamic range can be preserved by using HDCD 16-bit amplitude encoding and decoding, but without the benefit of HDCD A/D conversion and filtering.

### **HDCD Silence**

When producing HDCD release masters, at least 200 milliseconds (1/5 second or 6 NTSC video frames) of "HDCD Silence" must be provided before the beginning of each segment of program audio. HDCD Silence is simply an HDCD signal with no program content. "Digital (Video) Black" may be inserted prior to the 200 msec of HDCD Silence and immediately following the end of HDCD program audio. The 200 msec of HDCD Silence allows HDCD playback equipment time to perform any necessary switching or level adjustment.

### **Processing HDCD 16-bit Signals**

No digital processing which alters the bit structure of an HDCD 16-bit signal can be performed without losing the HDCD amplitude encoding information hidden in the signal's LSB. "Digital processing" includes any level change, EQ, dither, rounding, etc. Editing which does not affect the bit structure of the 16-bit HDCD encoded signal, such as butt splices or rapid cross fades, is OK. Cross fades should not be longer than 100 msec (3 video frames). At least 30 msec (1 frame) should exist between the end of a splice or cross fade and the beginning of a signal level transient. This period is required so that an HDCD decoder has time to recognize the HDCD code.

## A/D Conversion of Analog Tape Recordings

---

To obtain the very best possible quality when converting analog master tapes to digital masters using the Model Two, the following steps are recommended.

1. The outputs of the analog machine should be “hot rodded” directly to the analog inputs of the Model Two using minimum length runs of high quality cable, without going through a console or patch bay. Record levels should be set using only the analog input attenuator on the Model Two and the output level trim on the analog machine. If EQ or other processing of the analog signal is necessary, a high quality analog EQ or processing unit should be connected directly into the “hot rod” path without using a patch bay. In some cases, where only simple treble EQ is required, the play EQ on the analog machine can be adjusted, eliminating the need for an outboard EQ unit. The idea is to keep the analog signal path as short as possible.
2. The analog transfer should be made with the Model Two's A/D converter set to 24-bit at the highest possible sampling rate. If the A/D conversion frequency is 44.1 or 48 kHz, one AES output can feed a 24-bit digital recorder while the other AES output is fed to a 24-bit editing DAW. Thus, a 24-bit, 44.1 or 48 kHz archive recording can be made at the same time the DAW is being loaded.
3. Digital processing in the workstation that involves level shifting, EQ etc. should be carefully evaluated for sonic quality. High quality 24-bit editors, if set up correctly, can sound quite neutral when used for assembling and sequencing segments, however level shifting, EQ, and other processing operations can sometimes create audible distortions.
4. If the digital editor's level control doesn't sound sonically neutral, peak levels for the HDCD 16-bit release master can be adjusted using the DSP Gain feature of the Model Two, which has extremely low distortion. Set the Model Two to 24-bit digital in, 16-bit digital out mode, using the DIG44-16 preset. Feed the 24-bit output of the workstation to the Model Two, and use DSP Gain to adjust the 16-bit peak level, which can be up to 6 dB above full scale if Peak Extend is used. (monitor HDCD amplitude decoding should be turned alternately on and off while monitoring the analog D/A output of the Model Two when setting levels using Peak Extend to hear any Peak Extend limiting with undecoded playback.)

*No digital processing, including any form of EQ, level shifting, dither, rounding or truncation can be performed on HDCD encoded signals without losing the hidden LSB code that allows HDCD filtering and decoding. However, cuts or rapid ( $\leq 100$  ms) cross fades will not disrupt playback filtering or decoding and are OK.*

---

## Creating the 16-bit HDCD Release Sound You Want

---

During HDCD 16-bit A/D conversion, or after HDCD 24-bit or 20-bit A/D conversion and 24-bit or 20-bit digital processing, the Model Two's HDCD 16-bit amplitude encoding options, Peak Extension, HDCD Limiting, Low Level Extension, and HDCD 16-bit Dithers, are used to produce the best possible 16-bit HDCD encoded release masters from an analog or 24-bit or 20-bit source. When used correctly, these options allow the Model Two to accurately preserve the sound of different sources for both 16-bit undecoded and HDCD 16-bit decoded playback, whether they have wide dynamic range with infrequent short duration peaks, such as most classical music or jazz, or are compressed or hard edged with little dynamic range, typical of a lot of pop and rock.

Detailed descriptions of the amplitude encoding and dither options follow below, after which there are suggested operating techniques for both limited and wide dynamic range source material.

---

### HDCD 16-bit Amplitude Encoding and Dither Options

---

Note: The menu selections to access an option, starting from the Operating Menu, are shown in (parentheses).

#### Peak Extension & HDCD Limiting

For Peak Extension, from the Operating Menu select (OPS 2/PEAKEXT/ON). For HDCD Limiting, select (OPS 2/PEAKEXT/LIMIT).

Peak Extension is a restorable (with HDCD decoding) soft peak limiter that allows peak levels up to 6 dB above standard full scale level (+6 dBfs) on HDCD 16-bit recordings without generating "overs". The limiter has a carefully crafted "easy-over" curve, designed to mimic the sound of analog tape saturation that operates over an input signal level range of -3 dBfs to +6 dBfs, in effect squeezing the top 9 dB of the input signal's range into the top 3 dB of the 16-bit recording.

During HDCD 16-bit decoded playback, Peak Extension peak limiting is undone by the HDCD decoder using a precisely mapped inverse of the limiting curve controlled by the hidden LSB code, and the dynamics of the original material are restored up to +6 dBfs, thus extending dynamic range by up to 6 dB.

HDCD Limiting functions exactly the same as Peak Extension during recording, except that during playback the limiting curve is not undone with HDCD decoding. During HDCD decoded playback, HDCD Limiting has the same effect as during undecoded playback.

Use of Peak Extension or HDCD Limiting is optional in the HDCD 16-bit encoding process.

---

## DSP Gain

From the Operating Menu select (LEVELS/DSPGAIN)

DSP Gain is a digital gain control that adjusts the level of digital input sources over a +6 to -25.9 dB range (+12 to -19.9 dB with Peak Extension) and has extremely low distortion. DSP Gain allows 24-bit or 20-bit input sources to be “fit” optimally into the more limited dynamic range of a 16-bit release format by setting peak levels as close as possible to 0 dBfs. Note: If Peak Extension is used, DSP Gain can set peak levels as high as + 6 dBfs. If DSP Gain is set below unity, for example at - 0.1 dB, then independent of the input level, the output level can be no greater than the DSP Gain setting relative to full scale record level. In this example, input levels which would drive the output higher than - 0.1 dB relative to peak record level are clipped at - 0.1 dB, and no “overs” can occur.

## Low Level Extension

From the Operating Menu select (OPS 2/LOWLVL/NORMAL).

Low Level Extension is an average signal level based low level compression / expansion system used on HDCD 16-bit amplitude encoded recordings which very gradually raises gain a preset amount when the average signal level drops below a preset threshold. During HDCD 16-bit decoded playback the compression curve is expanded back to linear gain by the HDCD decoder using a precisely mapped inverse of the compression curve controlled by a hidden code, producing a dynamic range and resolution floor beyond 16-bit. During undecoded playback low level information normally lost by standard 16-bit players is preserved, providing more accurate timbral and spatial reproduction.

There are two modes of Low Level Extension, “Normal” and “Special”. Normal mode begins to affect the input signal 45 dB below peak level, gradually raising the gain 4 dB as the level drops over an 18 dB range. Special mode begins to affect the input signal 39 dB below peak level, and gradually raises the gain 7.5 dB over a 26 dB range. Normal mode is optimized to provide the best combination of decoded dynamic range and resolution and undecoded compatibility. Special mode is designed to provide the best possible decoded dynamic range and resolution at some potential expense of undecoded compatibility. To access Special mode, from the Operating Menu select (SETUP/OUTPUT/HDCD\_16/LOWLVL/SPECIAL). Typically, Special mode is used only for HDCD 16-bit master tracking with the assumption that the recording will be decoded by the Model Two to a 24-bit or 20-bit word length for digital post production before being re-encoded to HDCD 16-bit using Normal mode to produce a release master.

*Use of Low Level Extension is optional in the HDCD 16-bit encoding process. Low Level Extension can be turned on and off “on the fly” whenever the signal level is above - 30 dBfs.*

## HDCD 16-bit Dithers

From the Operating Menu select (SETUP/OUTPUT/OUT\_1 or OUT\_2/DITHER or MORE...).

HDCD 16-bit dither options allow optimizing perceived timbral and spacial accuracy with different types of source material during HDCD 16-bit A/D conversion, or when converting 24-bit or 20-bit signals to HDCD 16-bit.

The dither options are: DITHER1, DITHER2, DITHER3, DITHER0, ROCK\_1, ROCK\_2, and ROCK\_3.

DITHER1 is usually preferred with most source material, and provides both excellent clarity and accurate timbre. DITHER1 is the default dither selected by the factory presets.

DITHER2 and DITHER3 produce subtle alterations in timbre and spatial "air", providing a "palette" of options for different source material.

DITHER0 is the original HDCD 16-bit dither, and has been superceded by mathematical advances in DITHER1. DITHER0 may still be preferred with some source material, and also allows matching previously recorded HDCD 16-bit material.

ROCK\_1, ROCK\_2, and ROCK\_3 are designed to be useful for certain types of dense, distorted source material to keep an "edge" to the sound when dithering from 24-bit or 20-bit signals to HDCD 16-bit. Each has a different "flavor" though they will all distort clean source material, as they are intentionally designed towards truncation in effect.

## Operating Techniques:

Listening to both undecoded as well as decoded 16-bit playback is important, since HDCD amplitude encoding effects such as Peak Extension limiting are more audible undecoded.

### **Limited Dynamic Range Pop or Rock**

The best method to record highly compressed, limited dynamic range material depends greatly on the results that are desired with undecoded playback.

Using Peak Extension allows very high average recording levels without "clipping" or generating "overs". This approach can be used to get the "hottest" possible sound (almost no dynamics) during undecoded playback for air play, with decoding restoring normal dynamics for home listening.

However, because Peak Extension limiting has an "easy over" curve that begins to affect the signal at - 3 dBfs, it usually shouldn't be used with highly compressed source material

that will almost always be in the limiting curve, unless a highly limited or distorted sound is desired during undecoded playback.

Typically, Peak Extension recordings do not have the “crunch” or “edge” produced by hard clipping that is sometimes desired for certain types of rock material.

To get a hard “crunch” without any “easy over” limiting, turn Peak Extend off and adjust DSPGAIN to a level just below full scale, usually - 0.1 dB. The digital input signal level can then be adjusted using an external device such as a 24-bit editing workstation. This allows as much clipping as desired without generating any “overs”. To eliminate the need for an external gain adjusting device, the Model Two can be put into a dual output mode with digital output 2 set to HDCD\_24, and digital output 1 set to HDCD\_16, and offset -0.1 dB relative to output 2 using OUT1OFS in the Levels Menu (see page 36). DSPGAIN can then be adjusted to provide “crunch” on digital output 1 without generating any “overs”. Digital output 2 may then “over”, but isn't used.

When a “dry” or “punchy” low level sound is desired with limited dynamic range material that has little ambient information, Low Level Extension can be turned off.

## Wide Dynamic Range Jazz or Classical

This type of material typically has infrequent, short duration peaks such as snare drum rim shots, cymbal crashes, bass drum hits, etc. These types of short duration peaks can be limited by as much as 5 dB or 6 dB using Peak Extension with little audible effect during undecoded playback, allowing the average recorded level to be raised which improves overall resolution and fidelity.

Low Level Extension, set to Normal mode, should almost always be used with wide dynamic range material as it greatly aids in preserving the low level ambient and timbral information that gives “life” and naturalness to recordings.

With certain types of source material, such as a very low level passage in a noisy analog tape, Low Level Extension may occasionally cause an audible shift or “breathing” of the noise floor during undecoded playback. Low Level Extension can be turned off “on the fly” prior to such passages when the signal level is above - 30 dBfs, and turned back on afterwards, again when the signal level is above - 30 dBfs, to preserve the best possible fidelity for the remainder of the recording. However, with source material that is very noisy, Low Level Extension should be left off, as the noise of the source will set the resolution floor.

## Menu Structure

The menu structure is shown in tree form on page 40. The top level menu is the Operating Menu. To get to the Operating Menu from any other menu, press and hold the Menu Up button. The active modes of the function buttons are labeled above them on the graphic display. For example, from the Operating Menu, pressing the function button labeled OPS 2 will call up the Second Operating Menu. Some menus display the option MORE... which selects an additional page in the menu. For example, from the Setup Menu, pressing MORE... will select the second page of the Setup Menu, and so on. Pressing MORE... on the last page of a multiple page menu will roll back to the first page of the menu. The Recall Presets and Store Presets Menus may have multiple pages depending on the number of presets stored. The menu selections necessary to access a menu or feature, starting from the Operating Menu, are shown in (parentheses).

```

OPERATING MENU      ANALOG TO 44.1
                    OUTPUT 1:  HDCD16
                    OUTPUT 2:  HDCD24
                    REF LEVEL: -14
NORMAL  OUT_1
FINE    OUT_2
BITS    DIG_IN
MTRMODE MTRSRCE OPS 2  LEVELS  SETUP

```

The menu name, OPERATING MENU shown above, always appears in the upper left hand corner of the display. The selected Operating Mode appears on the first line after the menu name or on the second line below the menu name. If 44.1 kHz is selected as the Base Sample Rate, the Operating Modes are: AD\_44.1 (shown above), DD44-44, AD+DD44, AD\_88.2, DD88-44, DD44-88, DD88-88, AD176.4, DD176.4, DD176-88, DD176-44, DD88-176 and DD44-176. If 48 kHz is selected as the Base Sample Rate, the Operating Modes are: AD\_48, DD48-48, AD+DD48, AD\_96, DD96-48, DD48-96, DD96-96, AD192, DD192, DD192-96, DD192-48, DD96-192 and DD48-192. The Base Sample Rate and Operating Modes are selected in the Operating Mode Menu (SETUP/MODE).

The word length set for digital output 1, OUTPUT 1: (HDCD16 shown above), appears below the menu name or below the operating mode. The word length set for digital output 2, OUTPUT 2: (HDCD24 shown above), appears under the digital output 1 word length. Output word length options are: HDCD24, HDCD20, or HDCD16. Output word lengths are set in the Digital Output Menu (SETUP/OUTPUT/OUT\_1 or OUT\_2).

The meter reference level, REF LEVEL: (-14 shown above), appears on the second, third, or fourth line of the menu. The meter reference level range is between -6dB and -21dB and is set in the Meter Setup Menu. The bottom line displays the active modes of the five Function Buttons and varies for each menu.

Legends: [ ] = Menu Name

- = Toggle Select
- ⊗ = Only in DD4X/2X to 1X Modes
- \* = Deleted if 2X or 4X Sample Rate
- Σ = Only if 2X Sample Rate
- = Deleted in AD+DD1X Mode
- + = Only in AD+DD1X Mode
- ◇ = Only if different Output 1&2 Word Lengths
- Å = Only if 2X or 4X Sample Rate
- = Follows Output 1 in DD4X/2X to 1X



Rev. C - January 2002

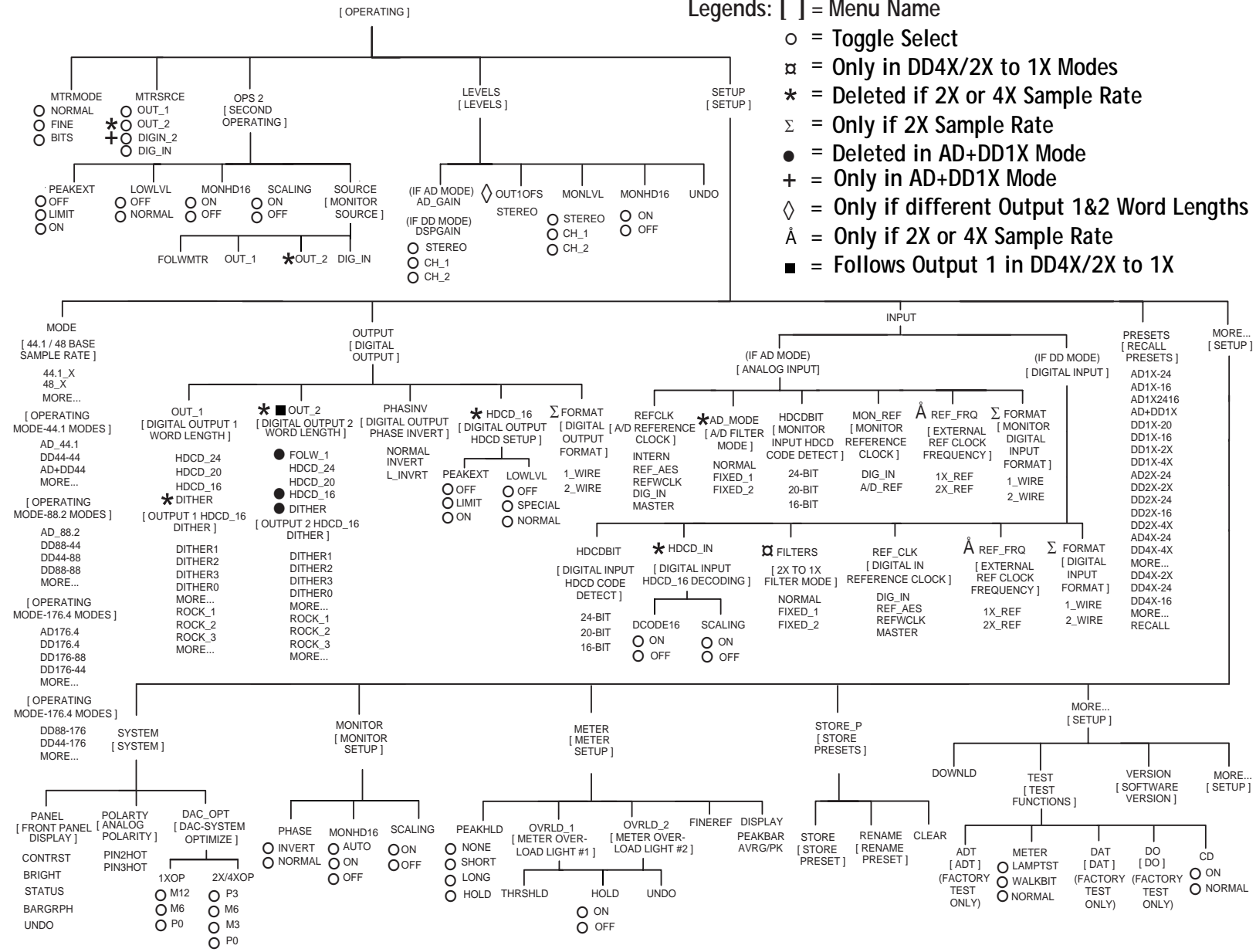



## Menu Descriptions

The selections to access a menu or feature, starting from the Operating Menu, are shown in (parentheses). **The menu descriptions shown are with the 44.1 kHz Base Sample Rate selected. If 48 kHz is selected, the menus remain the same, except multiples of 48 replace 44.1.** The menu descriptions follow the order of the Menu Tree on page 40.

### Operating Menu

The Operating Menu is the top level menu. All other menus are reached from this menu.

```

OPERATING MENU          ANALOG TO 44.1
                        OUTPUT 1:  HDCD16
                        OUTPUT 2:  HDCD24
                        REF LEVEL: -14
NORMAL  OUT_1
FINE    OUT_2
BITS    DIG_IN
MTRMODE MTRSRCE OPS 2  LEVELS  SETUP
  
```

Function button #1 (MTRMODE) toggles between the Meter Display Mode settings. Repeated button pushes choose NORMAL, FINE, and BITS.

Function button #2 (MTRSRCE) toggles between the Meter Sources. Repeated button pushes choose OUT\_1, OUT\_2, and DIG\_IN. In AD+DD44 mode only, DIGIN\_2 also appears.

OUT\_1 = Digital output 1 is used as the meter source.

OUT\_2 = Digital output 2 is used as the meter source.

DIG\_IN = Digital input 1 is used as the meter source.

DIGIN\_2 = Digital input 2 is used as the meter source. (AD+DD44 only)

For additional information on Meter Mode and Source selection see page 14 in the Set-Up & Operation section.

Function button #3 (OPS 2) selects the Second Operating Menu which contains the most often used HDCD 16-bit encode and monitor controls, and selection of the Monitor Source Menu (SOURCE). Function button #4 (LEVELS) selects the Levels Menu. Function button #5 (SETUP) selects page one of the Setup Menu. Descriptions of the Second Operating Menu, Monitor Source Menu, Levels Menu, and Setup Menu are on pages 41 to 45.

### Second Operating Menu

The Second Operating Menu is reached from the Operating Menu by selecting (OPS 2).

```

SECOND OPERATING MENU  ANALOG TO 44.1
HDCD16 ENCODE
OFF
LIMIT  OFF  ON
ON     NORMAL OFF
PEAKEXT LOWLVL MONHD16 SCALING SOURCE
  
```

Function Buttons 1 - 4 select HDCD 16-bit encode and monitor modes. Button #1 (PEAKEXT) selects if Peak Extension or HDCD Limiting are on or off, button #2 (LOWLVL) selects if normal Low Level Extension is on or off, button #3 (MONHD16) selects if HDCD 16-bit amplitude decoding during monitoring is on or off, and button #4 (SCALING) selects if Gain Scaling during monitoring is on or off. Button # 5 (SOURCE) selects the Monitor Source Menu. See pages 35, 36, 51, 69 and 70 for additional information on Peak Extension, HDCD Limiting, Low Level Extension, and Gain Scaling.

### Monitor Source Menu

The Monitor Source Menu is reached from the Operating Menu by selecting (OPS 2/SOURCE).

```

MONITOR SOURCE MENU  ANALOG TO 44.1
REF LEVEL: -14       OUTPUT 1:  HDCD16
                    OUTPUT 2:  HDCD24

FOLWMTR OUT_1  OUT_2  DIG_IN

```

Function buttons 1 - 4 select the monitor source. Button #1 (FOLWMTR) selects the meter source as the monitor source, button #2 (OUT\_1) selects digital output 1, button #3 (OUT\_2) selects digital output 2, and button #4 (DIG\_IN) selects digital input 1 as the monitor source. Pressing ENTER activates the selected source.

In follow meter mode, (FOLWMTR) the monitor source is the same as the meter source selected in the Operating Menu. The other modes allow different sources to be displayed on the meters while the monitor source remains constant.

### Levels Menu

The Levels Menu is reached from the Operating Menu by selecting (LEVELS). Analog input level, digital signal level, monitor output level, and output 1 offset can be adjusted in the Levels Menu. The menu appears in different forms depending on the selected operating mode. Some examples are shown below.

In a 44.1 kHz A/D mode (AD\_44.1 or AD+DD44):

```

LEVELS MENU  ANALOG TO 44.1
REF LEVEL: -14

STEREO      STEREO
CH_1        CH_1    ON
CH_2        STEREO CH_2  OFF
AD_GAIN    OUT1OFS MONLVL MONHD16 UNDO

```

In 44.1 kHz Digital Input mode (DD44-44):

```
LEVELS MENU    DIG 44 TO 44.1
REF LEVEL: -14

STEREO          STEREO
CH_1            CH_1   ON
CH_2            CH_2   OFF
[ DSPGAIN ] OUT10FS MONLVL MONHD16 UNDO
```

In 88.2 kHz A/D mode (AD\_88.2):

```
LEVELS MENU    ANALOG TO 88.2
REF LEVEL: -14

STEREO          STEREO
CH_1            CH_1
CH_2            CH_2
[ AD_GAIN ]     MONLVL          UNDO
```

In 176.4 kHz A/D mode (AD176.4):

```
LEVELS MENU    ANALOG TO 176
REF LEVEL: -14

STEREO          STEREO
CH_1            CH_1
CH_2            CH_2
[ AD_GAIN ]     MONLVL          UNDO
```

Function button #1 selects STEREO, CH\_1, or CH\_2 control of either analog input level (AD\_GAIN) in A/D modes, or digital signal level (DSPGAIN) in Digital Input modes. AD\_GAIN adjusts the analog input signal level in the digital domain. Raising A/D gain 1 dB is equivalent to raising the analog input level 1 dB. The A/D gain range is from 0 dB to + 3.1 dB in 0.05 dB steps. DSPGAIN adjusts digital signal level. The DSP gain range is from +6 dB to -25.9 dB (+12 to -19.9 with Peak Extend), in 0.1 dB steps. The Rotary Control is used to set both AD\_GAIN and DSPGAIN.

Function button #2 (OUT10FS) selects stereo control of the level of digital output 1 relative (offset) to digital output 2. The gain offset range is from + 6 dB to - 9.9 dB (+12 to - 3.9 dB with Peak Extend), in 0.1 dB steps. OUT10FS is deleted if digital output 2 is set to FOLW\_1. In 88.2 kHz and 176.4 kHz Operating Modes, OUT10FS is deleted.

Function button #3 (MONLVL) toggles between three monitor output level control selections; STEREO, CH\_1, and CH\_2. The Rotary Control is then used to set the monitor level. For 44.1 kHz monitoring, MONLVL sets absolute output level with values ranging from +24

to -78 dBu, selectable in 0.1 dB nominal steps (actual step resolution is 0.188 dB). For 88.2 and 176.4 kHz monitoring, the level range is +24 to -11.9 dBu in actual 0.1 dB steps.

Function button #4 (MONHD16) when set to the OFF position allows listening to HDCD 16-bit signals through the D/A analog outputs without HDCD amplitude decoding. For more information on operation of the MONHD16 control see the Monitor Setup Menu on page 61.

```

LEVELS MENU  DIG 44 TO 44.1  CH_1:  0.0
REF LEVEL: -14                CH_2:  0.0
                                ENTER=KNOB OFF
                                ACCEPT VALUE
STEREO          STEREO
CH_1            CH_1      ON
CH_2          STEREO  CH_2      OFF
DISPGAIN  OUT10FS  MONLVL  MONHD16 UNDO
  
```

In the top right corner of the menu, the current level values are displayed. The Rotary Control is used to change levels. While the Rotary Control is active, pressing function button #5 (UNDO) deactivates the control and returns the level setting to its previous value. When the desired level is set, pressing the ENTER button accepts it and deactivates the knob. Toggling to a different selection will keep the new level. If the Levels Menu is exited while the Rotary Control is active, it will remain active. Rotating the control one step in either direction will recall the Levels Menu with the control still active. This allows, for example, pushing the Menu Up button to get to the Operating Menu, selecting a different meter mode and returning directly to level adjustment by rotating the control, or pushing the Menu Down button.

## Setup Menu

The Setup Menu is reached from the Operating Menu by selecting (SETUP).  
Page one of the Setup Menu:

```

SETUP MENU
DIG 44 TO 44.1: 24 BIT
OUTPUT 1:  HDCD16  PEAK EXTEND OFF
OUTPUT 2:  HDCD24  LOW LEVEL OFF
REF LEVEL: -14    MONITOR SCALING OFF
MODE  [OUTPUT]  INPUT  PRESETS MORE...
  
```

Function buttons 1-4 select different menus. Button #1 (MODE) selects the 44.1/48 Base Sample Rate Menu and the Operating Mode Menus, button #2 (OUTPUT) selects the Digital Output Menu, button #3 (INPUT) selects the Analog Input Menu in A/D modes and the Digital Input Menu in D/D modes. Button #4 (PRESETS) selects the Recall Presets Menu, and button #5 (MORE...) selects page two of the Setup Menu. Descriptions of the above menus begin on pages 45, 47, 52, 56 and 59.

Page two of the Setup Menu:

```
SETUP MENU
DIG 44 TO 44.1: 24 BIT
OUTPUT 1:  HDCD16   PEAK EXTEND OFF
OUTPUT 2:  HDCD24   LOW LEVEL OFF
REF LEVEL: -14     MONITOR SCALING OFF

SYSTEM  MONITOR METER  STORE_P  MORE...
```

Button #1 (SYSTEM) selects the System Menu, button #2 (MONITOR) selects the Monitor Setup Menu, button #3 (METER) selects the Meter Setup Menu, button #4 (STORE\_P) selects the Store Presets Menu, and button #5 (MORE...) selects page three of the Setup Menu. Descriptions of the above menus begin on pages 59, 61 and 63.

Page three of the Setup Menu:

```
SETUP MENU
DIG 44 TO 44.1: 24 BIT
OUTPUT 1:  HDCD16   PEAK EXTEND OFF
OUTPUT 2:  HDCD24   LOW LEVEL OFF
REF LEVEL: -14     MONITOR SCALING OFF

DOWNLD  TEST  VERSION  MORE...
```

Button #1 (DOWNLD) activates the system software download procedure. Prior to initiating download, the following message is displayed, "Download new system file? Press ENTER to confirm, or any other key to cancel". Pressing ENTER brings up the Select Baud Rate Menu to start the download process. Refer to System Software Download on page 65. Button #2 (TEST) selects the Test Menu, button #3 (VERSION) selects the Software Version Menu, button #5 (MORE...) returns to page one of the Setup Menu. Descriptions of the above menus begin on page 64.

### 44.1/48 Base Sample Rate Menu

The 44.1/48 Base Sample Rate Menu is reached from the Operating Menu by selecting (SETUP/MODE).

```
44.1/48 BASE SAMPLE RATE MENU
DIG 44 TO 44.1: 24 BIT
OUTPUT 1:  HDCD16   PEAK EXTEND OFF
OUTPUT 2:  HDCD24   LOW LEVEL OFF
REF LEVEL: -14     MONITOR SCALING OFF

44.1_X  48_X  MORE...
```

Button #1 (44.1\_X) selects 44.1 kHz as the base sample rate for all Model Two operating

modes. When 44.1\_X is selected, all operating modes in the Operating Mode Menu operate at 44.1 kHz or 2X (88.2 kHz) or 4X (176.4 kHz) multiples of 44.1 kHz. Button #3 (48\_X) selects 48 kHz as the base sample rate for all Model Two operating modes. When 48\_X is selected, all operating modes in the Operating Mode Menu operate at 48 kHz or 2X (96 kHz) or 4X (192 kHz) multiples of 48 kHz. All factory presets in the Recall Presets Menu are labeled 1\_X, 2\_X or 4\_X and automatically operate at multiples of 44.1 kHz or 48 kHz depending on which base sample rate is selected. Button #5 (MORE...) selects the Operating Mode 1\_X Modes Menu.

### Operating Mode 1\_X Modes Menu

The Operating Mode 1\_X Modes Menu is reached from the Operating Menu by selecting (SETUP/MODE/MORE...).

```

OPERATING MODE MENU - 44.1 MODES
DIG 44 TO 44.1: 24 BIT
OUTPUT 1:  HDCD16   PEAK EXTEND OFF
OUTPUT 2:  HDCD24   LOW LEVEL OFF
REF LEVEL: -14     MONITOR SCALING OFF

AD_44.1  DD44-44  AD+DD44  MORE...
  
```

Function buttons 1-3 select the operating modes. Button #1 (AD\_44.1) selects 44.1 kHz A/D conversion mode, button #2 (DD44-44) selects 44.1 kHz digital input mode, button #3 (AD+DD44) selects 44.1 kHz A/D conversion simultaneous with 44.1 kHz digital input mode, button #5 (MORE...) selects the Operating Mode 2\_X Modes Menu. Pressing ENTER activates the selected mode.

### Operating Mode 2\_X Modes Menu

```

OPERATING MODE MENU - 88.2 MODES
DIG 44 TO 44.1: 24 BIT
OUTPUT 1:  HDCD16   PEAK EXTEND OFF
OUTPUT 2:  HDCD24   LOW LEVEL OFF
REF LEVEL: -14     MONITOR SCALING OFF

AD_88.2  DD88-44  DD44-88  DD88-88  MORE...
  
```

Button #1 (AD\_88.2) selects 88.2 kHz A/D conversion mode, button #2 (DD88-44) selects 88.2 kHz digital input to 44.1 kHz digital output mode, button #3 (DD44-88) selects 44.1 kHz digital input to 88.2 kHz digital output mode, button # 4 (DD88-88) selects 88.2 kHz digital input to 88.2 kHz digital output mode, and button # 5 (MORE...) selects the Operating Mode 4\_X Modes Menu. Pressing ENTER activates the selected mode.

## Operating Mode 4\_X Modes Menu

```

OPERATING MODE MENU - 176.4 MODES
DIG 44 TO 44.1: 24 BIT
OUTPUT 1:  HCDC16   PEAK EXTEND OFF
OUTPUT 2:  HCDC24   LOW LEVEL OFF
REF LEVEL: -14     MONITOR SCALING OFF

AD176.4 DD176.4 D176-88 D176-44 MORE...

```

Button #1 (AD176.4) selects 176.4 kHz AD mode, button #2 (DD176.4) selects 176.4 kHz to 176.4 kHz DD mode, button #3 (D176-88) selects 176.4 kHz to 88.2 kHz DD mode, button #4 (D176-44) selects 176.4 kHz to 44.1 kHz DD mode, button #5 (MORE...) selects page two of the Operating Mode 4\_X Modes Menu. Pressing ENTER activates the selection.

Page two of the Operating Mode 4\_X Modes Menu:

```

OPERATING MODE MENU - 176.4 MODES
DIG 44 TO 44.1: 24 BIT
OUTPUT 1:  HCDC16   PEAK EXTEND OFF
OUTPUT 2:  HCDC24   LOW LEVEL OFF
REF LEVEL: -14     MONITOR SCALING OFF

D88-176 D44-176 MORE...

```

Button #1 (D88-176) selects 88.2 kHz to 176.4 kHz DD mode, button #2 (D44-176) selects 44.1 kHz to 176.4 kHz DD mode, and button #5 (MORE...) selects the 44.1/48 Base Sample Rate Menu. Pressing ENTER activates the selected mode.

Descriptions of the Operating Modes are on pages 19-23, and details of using each mode are on pages 26 to 31, in the Setup & Operation section.

**Digital Output Menu**

The Digital Output Menu is reached from the Operating Menu by selecting (SETUP/OUTPUT). This menu appears in different forms depending on whether 1\_X, 2\_X or 4\_X digital output operating modes are selected.

In 44.1 kHz (1\_X) digital output operating modes:

```

DIGITAL OUTPUT MENU  DIG 44 TO 44.1
OUTPUT 1:  HCDC16   PEAK EXTEND OFF
OUTPUT 2:  HCDC24   LOW LEVEL OFF

OUT_1 OUT_2 PHASINV HCDC_16

```

Function button #1 (OUT\_1) selects the Digital Output 1 Word Length Menu, button #2 (OUT\_2) selects the Digital Output 2 Word Length Menu, button #3 (PHASINV) selects the Digital Output Phase Invert Menu, and button #4 (HDCD\_16) selects the Digital Output HDCD Setup Menu. Descriptions of these menus are on pages 48 to 51.

In 88.2 kHz (2\_X) digital output operating modes:

```
DIGITAL OUTPUT MENU    DIG 88 TO 88.2
OUTPUT:    HDCD24-2W

[OUTPUT]                PHASINV                FORMAT
```

In 88.2 kHz (2\_X) digital output operating modes, function button #2 (OUT\_2) is deleted, and button #5 (FORMAT) is added. FORMAT selects the Digital Output Format Menu described on page 52. In 176 kHz (4\_X) digital output modes the Digital Output Menu is the same as in 88.2 kHz modes, except that function button #5 (FORMAT) is deleted.

### Digital Output 1 Word Length Menu

In 44.1 kHz (1\_X) digital output operating modes, the Digital Output 1 Word Length Menu is reached from the Operating Menu by selecting (SETUP/OUTPUT/OUT\_1).

```
DIGITAL OUTPUT 1 WORD LENGTH MENU
DIG 44 TO 44.1: 24 BIT
OUTPUT 1:    HDCD16

HDCD_24  HDCD_20                [HDCD_16]  DITHER
```

Function buttons 1, 2, and 4 select the digital output word length, # 5 (DITHER) selects the Output 1 HDCD\_16 Dither Menu. Pressing ENTER activates the selected function.

### Output 1 HDCD\_16 Dither Menu

The Output 1 HDCD\_16 Dither Menu is reached from the Operating Menu by selecting (SETUP/OUTPUT/OUT\_1/DITHER).

```
OUTPUT 1 HDCD_16 DITHER MENU
DIG 44 TO 44.1: 24 BIT
OUTPUT 1:    HDCD16

[DITHER1]  DITHER2  DITHER3  DITHER0  MORE...
```



Function buttons 1-4 select different HDCD 16-bit dither types. #5 selects the second page of the Dither Menu. Pressing ENTER activates the selected dither type. Dither 1 is the default dither used in the factory setup presets and provides excellent resolution and accurate timbre with most source material. Dither 2 provides a slightly different sonic “flavor” that may be preferred with some sources. Dither 3 again is a different flavor with some emphasis of “air” in the source. Dither 0 is the original HDCD 16-bit dither provided in early Model One software versions.

Page two of the Output 1 HDCD\_16 Dither Menu:

```
OUTPUT 1 HDCD_16 DITHER MENU
DIG 44 TO 44.1: 24 BIT
OUTPUT 1:  HDCD16

ROCK_1  ROCK_2  ROCK_3  MORE...
```

Function buttons 1-3 select three HDCD Rock dither types. #5 selects the first page of the Dither Menu. Pressing ENTER activates the selected dither type. ROCK\_1, ROCK\_2, and ROCK\_3 are designed to be useful for certain types of dense, distorted source material to keep an “edge” to the sound when dithering from 24-bit or 20-bit signals to HDCD 16-bit. Each has a different “flavor” though they will all distort clean source material, as they are designed towards truncation in effect. See page 37 for descriptions of the HDCD dithers.

### Digital Output 2 Word Length Menu

In 44.1 kHz (1\_X) digital output operating modes, the Digital Output 2 Word Length Menu is reached from the Operating Menu by selecting (SETUP/OUTPUT/OUT\_2).

```
DIGITAL OUTPUT 2 WORD LENGTH MENU
DIG 44 TO 44.1: 24 BIT
OUTPUT 2:  HDCD24

FOLW_1  HDCD_24  HDCD_20  HDCD_16  DITHER
```

The Digital Output 2 Word Length Menu is the same as the Digital Output 1 Word Length Menu except for the addition of the option FOLW\_1, selected by function button #1. Selecting FOLW\_1 causes digital output 2 to automatically follow the configuration of digital output 1, and deletes the Output 2 HDCD\_16 Dither Menu selection. FOLW\_1 is deleted in AD+DD44 operating mode.

### Output 2 HDCD\_16 Dither Menu

The Output 2 HDCD\_16 Dither Menu is reached from the Operating Menu by selecting (SETUP/OUTPUT/OUT\_2/DITHER).

```
OUTPUT 2 HDCD_16 DITHER MENU
DIG 44 TO 44.1: 24 BIT
OUTPUT 2:  HDCD16

DITHER1 DITHER2 DITHER3 DITHER0 MORE...
```

Function buttons 1-4 select HDCD dithers. #5 selects the second page of the Dither Menu. Pressing ENTER activates the selected dither. The dithers are the same as those in the Output 1 HDCD\_16 Dither Menu. The Output 2 HDCD\_16 Dither Menu is deleted when FOLW\_1 is selected in the Digital Output 2 Word Length Menu.

Page two of the Output 2 HDCD\_16 Dither Menu:

```
OUTPUT 2 HDCD_16 DITHER MENU
DIG 44 TO 44.1: 24 BIT
OUTPUT 2:  HDCD16

ROCK_1  ROCK_2  ROCK_3  MORE...
```

Function buttons 1-3 select HDCD Rock dithers. #5 selects the first page of the Dither Menu. Pressing ENTER activates the selected dither. The dithers are the same as those in page two of the Output 1 HDCD\_16 Dither Menu.

### Digital Output Word Length Menu

In 88.2 or 176.4 kHz (2\_X or 4\_X) digital output operating modes, the Digital Output Word Length Menu is reached from the Operating Menu by selecting (SETUP/OUTPUT/OUTPUT).

```
DIGITAL OUTPUT WORD LENGTH MENU
DIG 88 TO 88.2: 24 BIT-2W
OUTPUT:  HDCD24-2W

HDCD_24  HDCD_20  HDCD_16
```

Function buttons 1, 2, and 4 select the digital output word length. Pressing ENTER activates the selected function

### Digital Output Phase Invert Menu

The Digital Output Phase Invert Menu is reached from the Operating Menu by selecting (SETUP/OUTPUT/PHASINV).

```
DIGITAL OUTPUT PHASE INVERT MENU

NORMAL INVERT L_INVRT
```

Function button #1 (NORMAL) selects normal phase, button #2 (INVERT) selects inverted absolute phase (both channels inverted), and function button #3 (L\_INVRT) selects inverted relative phase (left channel only inverted). Pressing ENTER activates the selected mode. Selecting L\_INVRT will light the System Status Indicator orange for "Non Standard Operation".

### Digital Output HDCD Setup Menu

The Digital Output HDCD Setup Menu is reached from the Operating Menu by selecting (SETUP/OUTPUT/HDCD\_16).

```
DIGITAL OUTPUT HDCD SETUP MENU

OFF LIMIT OFF SPECIAL
ON      NORMAL
PEAKEXT LOWLVL
```

Function button #1 (PEAKEXT) toggles between Peak Extension ON, HDCD Limiting (LIMIT) ON and OFF. Peak Extension is a restorable (with HDCD decoding) 9 dB soft peak limiter with a threshold of -3 dBfs that can increase dynamic range up to 6 dB when decoded. HDCD Limiting is the same as Peak Extension, except that HDCD decoding doesn't undo it.

Button #3 (LOWLVL) selects between three Low Level Extension options. When NORMAL mode is selected, HDCD 16-bit amplitude encoding uses a very gradual 4 dB restorable (with HDCD decoding) companding algorithm below -45 dBfs to improve low level resolution and increase dynamic range. Setting LOWLVL to OFF turns off low level signal companding. Setting LOWLVL to SPECIAL mode selects 7.5 dB companding with a threshold of -39 dBfs. The primary use of SPECIAL mode is to make HDCD master recordings on a 16-bit recorder which will then be decoded to 20-bit for editing. For more information on Peak Extension, HDCD Limiting and Low Level Extension see pages 35 and 36 in the Setup & Operation section and pages 69 and 70.

### Digital Output Format Menu

In 88.2 kHz (2\_X) digital output operating modes, the Digital Output Format Menu is reached from the Operating Menu by selecting (SETUP/OUTPUT/FORMAT).

```
DIGITAL OUTPUT FORMAT MENU
1_WIRE 2_WIRE
```

Function button #1 (1\_WIRE) selects single wire, double speed AES as the digital output format, button #3 (2\_WIRE) selects two wire, single speed AES as the digital output format. Pressing ENTER activates the selection.

### Analog Input Menu

In all AD modes, the Analog Input Menu is reached from the Operating Menu by selecting (SETUP/INPUT). This menu appears in different forms depending on whether 1\_X, 2\_X or 4\_X AD operating modes are selected.

In 44.1 kHz (1\_X) AD operating mode:

```
ANALOG INPUT MENU      A/D REF: INTERNAL
OUTPUT 1:  HDCD16      PEAK EXTEND OFF
OUTPUT 2:  HDCD24      LOW LEVEL OFF
REF LEVEL: -14         MONITOR SCALING OFF
REFCLK AD_MODE HDCDBIT MON_REF
```

The A/D REF clock mode is displayed on the top right of the menu and is set using the Reference Clock Menu, selected by function button #1 (REFCLK). Button #2 (AD\_MODE) selects the A/D Filter Mode Menu, button #3 (HDCDBIT) selects the Monitor Input HDCD Code Detect Menu, button #4 (MON\_REF) selects the Monitor Reference Clock Menu. Descriptions of these menus are on pages 53 and 54.

In 88.2 kHz (2\_X) AD operating mode:

```
ANALOG INPUT MENU      A/D REF: INTERNAL
OUTPUT:  HDCD24-2W
REF LEVEL: -14         MONITOR SCALING OFF
REFCLK HDCDBIT MON_REF REF_FRQ FORMAT
```



```
A/D FILTER MODE MENU

USE FIXED_1 FILTER MODE FOR
PREVIOUSLY ENCODED HDCD MATERIAL
( HDCD A/D -> D/A -> RE-A/D )

NORMAL    FIXED_1    FIXED_2
```

Function button #1 (NORMAL) selects normal HDCD dynamic decimation filtering. Function button #3 (FIXED\_1) selects a fixed decimation filter. If an HDCD A/D converted 44.1 kHz or 48 kHz digital recording (20-bit, 24-bit, or 16-bit) is converted back to analog for analog processing and again converted to digital, the FIXED\_1 filter should be used for the second A/D conversion. Function button #5 (FIXED\_2) selects another type of fixed decimation filter. Pressing ENTER activates the selection. If a fixed filter is selected, the System Status indicator lights orange to show a non-standard mode. (Fixed filter 1 should also be used for A/D frequency response testing.)

### Monitor Input HDCD Code Detect Menu

In all AD operating modes, the Monitor Digital Input Word Length Menu is reached from the Operating Menu by selecting (SETUP/INPUT/HDCDBIT).

```
MONITOR INPUT HDCD CODE DETECT MENU
ANALOG TO 44.1

24-BIT  20-BIT  16-BIT
```

Function buttons 1-3 select the digital input HDCD code detect word length. Pressing ENTER activates the selected word length.

In all AD operating modes, selecting DIG\_IN in the Operating Menu allows monitoring of digital sources, such as the output of a digital recorder being fed the digital outputs of the Model Two's A/D converters. The Monitor Input HDCD Code Detect Menu is used to set the word length of HDCD LSB code detection. If the word length of the digital input signal is different from the Code Detect setting, HDCD code will not be detected, even if the input signal is HDCD.

### Monitor Reference Clock Menu

In all AD operating modes, the Monitor Reference Clock Menu is reached from the Operating Menu by selecting (SETUP/INPUT/MON\_REF).



Function button #1 (DIG\_IN) selects the digital input data being monitored as the clock source, button #3 (A/D\_REF) selects the clock source selected in the A/D Reference Clock Menu as the clock source.

The Monitor Reference Clock Menu is used to select the D/A converter clock source when monitoring digital input signals while in AD operating modes. See page 26 for details.

### External Ref Clock Frequency Menu

In 2X or 4X AD and DD operating modes, the External Ref Clock Frequency Menu is reached from the Operating Menu by selecting (SETUP/INPUT/REF\_FRQ).

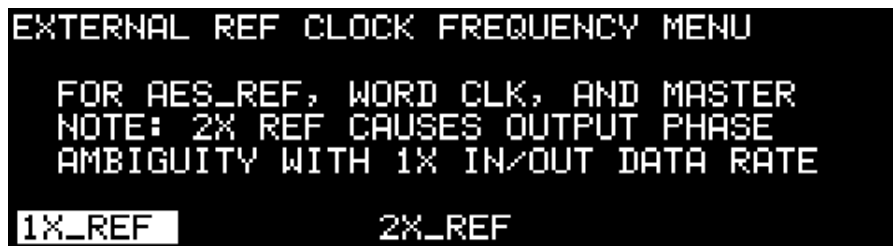

Function buttons #1 (1X\_REF) and #3 (2X\_REF) select the frequency of the external reference clock source when REF\_AES or REFCLK are selected in the A/D Reference Clock Menu and the frequency of the reference word clock output of the Model Two when MASTER is selected in the A/D Reference Clock Menu. See NOTE on page 27.

### Monitor Digital Input Format Menu

In 88.2 kHz (2\_X) AD operating mode, the Monitor Digital Input Format Menu is reached from the Operating Menu by selecting (SETUP/INPUT/FORMAT).

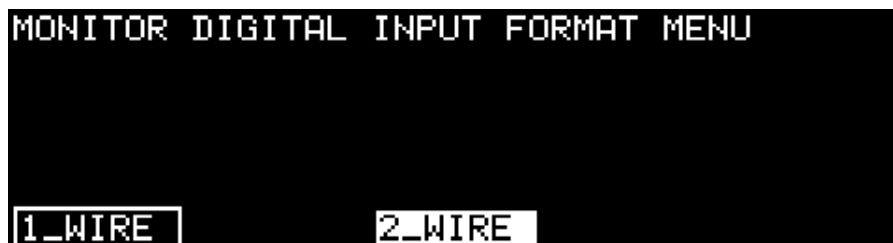

Function button #1 (1\_WIRE) selects single wire, double speed AES as the digital input

format, button #3 (2\_WIRE) selects two wire, single speed AES as the digital input format. Pressing ENTER activates the selection.

### Digital Input Menu

In all DD operating modes, the Digital Input Menu is reached from the Operating Menu by selecting (SETUP/INPUT). This menu appears in different forms depending on whether 1\_X, 2\_X or 4\_X digital input DD operating modes are selected.

In 44.1 kHz (1\_X) DD input modes:

```
DIGITAL INPUT MENU
DIG 44 TO 44.1: 24 BIT
OUTPUT 1:  HDCD16   PEAK EXTEND OFF
OUTPUT 2:  HDCD24   LOW LEVEL OFF
REF LEVEL: -14     MONITOR SCALING OFF
HDCDBIT          HDCD_IN          REF_CLK
```

Function button #1 (HDCDBIT) selects the Digital Input HDCD Code Detect Menu, button #3 (HDCD\_IN) selects the Digital Input HDCD\_16 Decoding Menu, button #5 (REF\_CLK) selects the Digital In Reference Clock Menu. Menu descriptions are on pgs. 56, 57 and 58.

In 88.2 kHz (2\_X) DD input modes:

```
DIGITAL INPUT MENU
DIG 88 TO 44.1: 24 BIT-2W
OUTPUT 1:  HDCD16   PEAK EXTEND OFF
OUTPUT 2:  HDCD16   LOW LEVEL OFF
REF LEVEL: -14     MONITOR SCALING OFF
HDCDBIT FILTERS REF_CLK REF_FRQ FORMAT
```

Function button #1 (HDCDBIT) selects the Digital Input HDCD Code Detect Menu, button #2 (FILTERS) selects the 2X to 1X Filter Mode Menu, button #3 (REF\_CLK) selects the Digital In Reference Clock Menu, button #4 (REF\_FRQ) selects the External Ref Clock Frequency Menu and button #5 (FORMAT) selects the Digital Input Format Menu. Descriptions of these menus are on pages 55, 56, 57 and 58. In 176 kHz (4\_X) DD input modes the Digital Input Menu is the same as in 88.2 kHz modes, except that function button #5 (FORMAT) is deleted.

### Digital Input HDCD Code Detect Menu

In all DD operating modes, the Digital Input HDCD Code Detect Menu is reached from the



Operating Menu by selecting (SETUP/INPUT/HDCDBIT).

```
DIGITAL INPUT HDCD CODE DETECT MENU
OUTPUT 1:  HDCD16   PEAK EXTEND OFF
OUTPUT 2:  HDCD24   LOW LEVEL OFF
REF LEVEL: -14     MONITOR SCALING OFF

24-BIT  20-BIT  16-BIT
```

Function buttons 1-3 select the digital input HDCD code detect word length. Pressing ENTER activates the selected word length.

The Digital Input HDCD Code Detect Menu is used to set the word length of HDCD LSB code detection in the digital input signal. Even if the input signal is HDCD, HDCD code will not be detected if the Code Detect setting is different from the word length of the input signal.

### Digital Input HDCD\_16 Decoding Menu

In DD44-44, DD44-88 or DD44-176 operating modes, the Digital Input HDCD\_16 Decoding Menu is reached from the Operating Menu by selecting (SETUP/INPUT/HDCD\_IN).

```
DIGITAL INPUT HDCD_16 DECODING MENU

ON  ON
OFF OFF
DCODE16 SCALING
```

Function button # 1 (DCODE\_16) toggles between HDCD 16-bit amplitude decoding ON or OFF. Button # 3 (SCALING) toggles between automatic 6 dB input level gain scaling ON or OFF.

Toggling DCODE\_16 to ON decodes, with automatic - 6 dB level scaling for Peak Extended signals, an HDCD 16-bit amplitude encoded input signal to a 24-bit signal that can be adjusted in level using DSP Gain and output as an HDCD 24-bit or 20-bit signal, and in DD44-44 mode, simultaneously as an HDCD 16-bit signal. Toggling SCALING to ON also scales the input level to - 6 dB for non Peak Extended signals, so that the average levels of peak extended and non-peak extended signals will match.

### 2X To 1X Filter Mode Menu

In DD88-44 and DD176-44 operating modes, the 2X to 1X Filter Mode Menu is reached from the Operating Menu by selecting (SETUP/INPUT/FILTERS).

```
2X TO 1X FILTER MODE MENU

NORMAL IS THE STANDARD HDCD FILTER
SET. ONE OF THE OTHERS MAY SOUND
BETTER WITH SOME SOURCES

NORMAL    FIXED_1    FIXED_2
```

The 2X to 1X Filter Mode Menu provides the same decimation filter choices for 2X digital input signals as the A/D Filter Mode Menu described on page 53.

### Digital In Reference Clock Menu

In all DD operating modes, the Digital In Reference Clock Menu is reached from the Operating Menu by selecting (SETUP/INPUT/REF\_CLK).

```
DIGITAL IN REFERENCE CLOCK MENU

EXTERNAL REFERENCE FREQUENCY: 1X

DIG_IN    REF_AES    REFWCLK    MASTER
```

Function button #1 (DIG\_IN) selects the digital input data as the clock source, button #2 (REF\_AES) selects the clock connected to the AES In Ref input, button #3 (REFWCLK) selects an external word clock connected to the Word Clock Ref connector and button #5 (MASTER) selects the Model Two's internal clock and feeds it to the Word Clock Ref connector, providing a master word clock output.

The Digital In Reference Clock Menu is used to select the D/A converter clock source when monitoring digital input signals while in DD operating modes. See page 26.

### Digital Input Format Menu

In 88.2 kHz (2\_X) input DD operating mode, the Digital Input Format Menu is reached from the Operating Menu by selecting (SETUP/INPUT/FORMAT).

```
DIGITAL INPUT FORMAT MENU

1_WIRE    2_WIRE
```

Function button #1 (1\_WIRE) selects single wire, double speed AES as the digital input

format, button #3 (2\_WIRE) selects two wire, single speed AES as the digital input format. Pressing ENTER activates the selection.

### Recall Presets Menu

The Recall Presets Menu is reached from the Operating Menu by selecting (SETUP/PRESETS).

```

RECALL PRESETS MENU  X=44.1 SAMPLE RATE
AD1X-24  DD1X-20  AD2X-24  DD2X-4X
AD1X-16  DD1X-16  DD2X-2X  AD4X-24
AD1X2416 DD1X-2X  DD2X-24  DD4X-4X
AD+DD1X  DD1X-4X  DD2X-16  MORE...
      FIXED: ANALOG to 1X HDCD24
[RECALL]
  
```

The Rotary Control is used to scroll through the stored presets. A brief description of the highlighted preset is displayed on the menu. For example, the description for the AD1X-24 preset is "FIXED: ANALOG to 1X HDCD24". Function button #1 (RECALL) selects the highlighted preset. When a preset is selected, the following message is displayed: "Recall this preset? Press ENTER to recall, or any other key to cancel". Pressing ENTER configures the system with the preset's contents.

Note: All System Menu settings (Front Panel Display, Analog Polarity and DAC-System Optimize) and Meter Setup Menu settings are not changed during preset loading. **Caution: selecting a different preset may change the Monitor Level setting!**

### System Menu

The System Menu is reached from the Operating Menu by selecting (SETUP/MORE.../SYSTEM).

```

SYSTEM MENU
[ ]
[ ]
[ ]
[PANEL]  POLARTY  DAC_OPT
  
```

Function button #1 (PANEL) selects the Front Panel Display Menu. Button #3 (POLARTY) selects the Analog Polarity Menu. Button #5 (DAC\_OPT) selects the DAC-System Optimize Menu. Descriptions of these Menus are on pages 60 and 61.

### Front Panel Display Menu

The Front Panel Display Menu is reached from the Operating Menu by selecting (SETUP/MORE.../SYSTEM/PANEL).



After pressing a function button, the Rotary Control is used to change the value of the selected item. Button #1 (CONTRST) selects Graphic Display contrast, button #2 (BRIGHT) selects Graphic Display brightness, button #3 (STATUS) selects System Status Indicator and Clock Indicator brightness, and button #4 (BARGRPH) selects Signal Level Meter bargraph brightness. All contrast and brightness setting ranges are from 0 (off) to 254 (full contrast/brightness). Button #5 (UNDO) cancels the setting change and ENTER activates the new setting. Once set, values are not altered during the loading or saving of presets or during power down.

### Analog Polarity Menu

The Analog Polarity Menu is reached from the Operating Menu by selecting (SETUP/MORE.../SYSTEM/POLARTY).



The function buttons select the XLR connector pin polarity of the Analog Input and Output ports. Button #1 (PIN2HOT) selects pin 2 hot and button #3 (PIN3HOT) selects pin 3 hot. Pressing ENTER activates the selected polarity. The analog polarity setting is not altered during the loading or saving of presets or during power down. Note: The Analog Polarity Menu is used to set the fixed polarity of the analog I/O. The Monitor Setup Menu should be used to change polarity temporarily while monitoring.

### DAC-System Optimize Menu

The DAC-System Optimize Menu is reached from the Operating Menu by selecting (SETUP/MORE.../SYSTEM/DAC\_OPT).

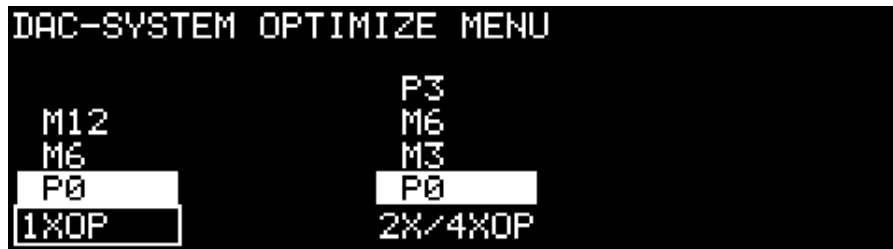

Function button #1 (1XOP) toggles between three levels of DAC dither for 44.1 kHz (1\_X) signals. Button #3 toggles between four levels of DAC dither for 88.2/176.4 kHz (2\_X/4\_X) signals. Once set, values are not altered during the loading or saving of presets or during power down. See further description on page 32.

### Monitor Setup Menu

The Monitor Setup Menu is reached from the Operating Menu by selecting (SETUP/MORE.../MONITOR).

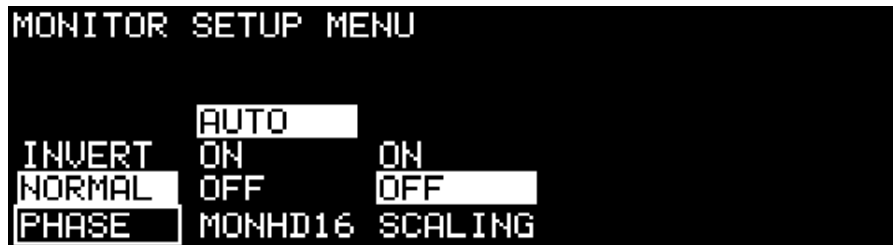

Function button #1 (PHASE) toggles the analog output (D/A) monitor phase setting between normal (NORMAL) and inverted (INVERT), button #2 (MONHD16) toggles HDCD 16-bit amplitude decoding of the monitor output between AUTO, ON, and OFF.

AUTO = Monitor decoding follows the monitor source.

ON = Monitor always attempts to decode.

OFF = Monitor never attempts to decode.

Toggling MONHD16 to OFF turns off amplitude decoding of Peak Extension and Low Level Extension. This allows using DSP gain to optimize peak extended levels for undecoded playback. Function button #3 (SCALING) selects between ON and OFF - 6 dB output level scaling. ON scales the monitor output level to - 6 dB for all signals except HDCD 16-bit signals recorded with peak extension, so that the average levels of peak extended and non-peak extended signals match.

### Meter Setup Menu

The Meter Setup Menu is reached from the Operating Menu by selecting (SETUP/MORE.../METER).

```

METER SETUP MENU
NONE
SHORT
LONG
HOLD          -14
PEAKHLD  OVRD_1 OVRD_2 FINEREF  PEAKBAR
          OVRD_1 OVRD_2 FINEREF  AVRGP/K
          OVRD_1 OVRD_2 FINEREF  DISPLAY

```

Function button #1 (PEAKHLD) toggles between four peak level hold settings. HOLD - holds peaks until cleared by the Meter Reset Button, LONG - peaks held for 4 seconds, SHORT - peaks held for 1.5 seconds, and NONE - peaks not held.

Button #2 (OVRD\_1) selects the Meter Overload Light #1 Menu and button #3 (OVRD\_2) selects the Meter Overload Light #2 Menu.

Button #4 (FINEREF) enables the Rotary Control to change the fine reference level setting. The fine reference level range is from -6 to -21 dBfs in 1 dB steps. Pressing ENTER activates the selected level. Note that the fine reference level is purely a metering function and does not affect signal input or output levels. Button #5 (DISPLAY) selects between a standard peak reading bar (PEAKBAR), and an average reading bar with a single pip peak indication (AVRG/PK). AVRG/PK mode displays both average levels, which determine perceived loudness and channel balance, and peak digital signal levels at the same time. The DISPLAY setting is not stored in presets.

### Meter Overload Light #1 Menu

The Meter Overload Light #1 Menu is reached from the Operating Menu by selecting (SETUP/MORE.../METER/OVRD\_1).

```

METER OVERLOAD LIGHT #1 MENU
          ON
          OFF
1        THRESHLD  HOLD          UNDO

```

Function button #1 (THRSHLD) enables the Rotary Control to change the overload light threshold setting. The threshold range for light #1 is from 1 to 4 successive full scale data words. Button #2 (HOLD) toggles between overload light hold ON and OFF. When hold is on, the overload light remains lit until cleared by the Meter Reset Button. When hold is off, the overload light follows the peak hold setting defined in the Meter Setup Menu. Button #5 (UNDO) cancels the setting change and ENTER activates the selection.

### Meter Overload Light #2 Menu

The Meter Overload Light #2 Menu is reached from the Operating Menu by selecting (SETUP/MORE.../METER/OVRD\_2).



The Meter Overload Light #2 Menu is the same as the Meter Overload Light #1 Menu except that the threshold range for light #2 is from 0 to 3 successive full scale data words greater than the setting for light #1. For example, if the threshold of light #1 is set to 1, light #2 can be set to a threshold of 1 to 4. If light #1 is set to 2, light #2 can be set to 2 to 5, and so on.

### Store Presets Menu

The Store Presets Menu is reached from the Operating Menu by selecting (SETUP/MORE.../STORE\_P).

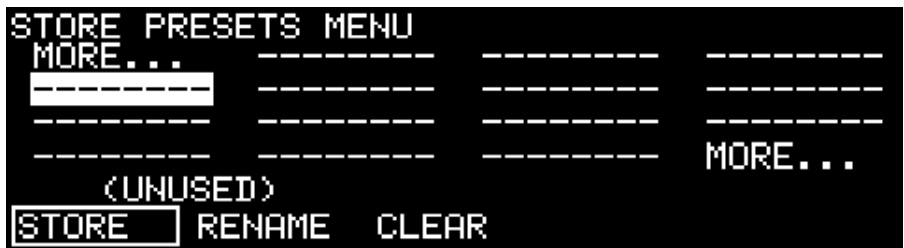

The Rotary Control is used to scroll through the presets. A brief preset description is displayed on menu line six. The description for blank presets is "UNUSED". Factory installed presets are indicated in parenthesis and cannot be stored, renamed, or erased. Function button #1 (STORE) selects the Store Preset Menu and function button #2 (RENAME) selects the Rename Preset Menu. Descriptions of these menus are below and on page 64. Function button #3 (CLEAR) erases the selected preset. After pressing button #3, the following message will be displayed: "Erase this preset? Press ENTER to erase, or any other key to cancel". Pressing ENTER will erase the selected preset.

### Store Preset Menu

The Store Preset Menu is reached from the Operating Menu by selecting (SETUP/MORE.../STORE\_P/STORE).

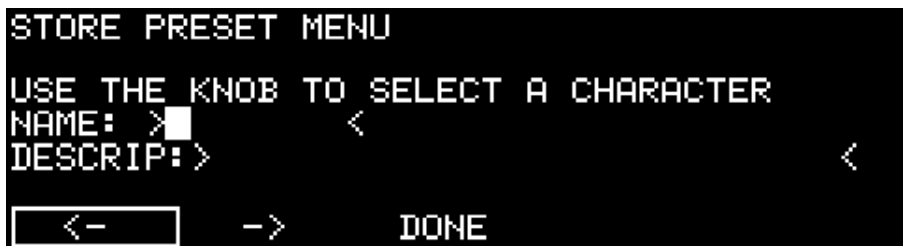

The Rotary Control is used to scroll through the available character set which includes letters, numbers, and symbols. Function buttons #1 and #2 move the active data entry point left and right through the data fields. The NAME field holds a maximum of 8 characters, and the DESCRIPTION field holds a maximum of 28 characters. Pressing button #3 (DONE) displays the following message "Accept these changes? Press ENTER to confirm, or any other key to cancel". Pressing ENTER saves the current system configuration and name entered as a preset and returns to the Store Presets Menu.

### Rename Preset Menu

The Rename Preset Menu is reached from the Operating Menu by selecting (SETUP/MORE.../STORE\_P/RENAME).

```

RENAME PRESET MENU
USE THE KNOB TO SELECT A CHARACTER
NAME: >A<
DESCRIP: > <
<- [ -> ] DONE
  
```

The Rename Preset Menu is used to rename a current preset. This menu is the same as the Store Preset Menu, except that only the new name, and not the current system configuration is saved.

### Test Functions Menu

The Test Functions Menu is reached from the Operating Menu by selecting (SETUP/MORE.../MORE.../TEST).

```

TEST FUNCTIONS MENU
LAMPST
WALKBIT
NORMAL
[ADT] METER DAT DO CD
  
```

Selecting METER LAMPST lights all of the meter LED's. Selecting METER WALKBIT lights each of the meter LED's sequentially. Selecting METER NORMAL returns the system status indicators and level meters to normal operation. CD is for test purposes only, and must be left in NORMAL for correct level metering.

The ADT, DAT and DO sub-menus are for field service and manufacturing test only.



## Software Version Menu

The Software Version Menu is reached from the Operating Menu by selecting (SETUP/MORE.../MORE.../VERSION).

```
SOFTWARE VERSION: 3.00  10/31/00
FPC HW: f.e
DSP HW: f.e
DIO HW: f.e
FPM TYPE 509
```

There are no selections on this menu. It displays software version and hardware revision status information only. Please have this information available when contacting Pacific Microsonics Technical Support.

## System Software Download

---

### Background

To allow performance or feature upgrades, new Model Two system software can be downloaded through the RS-232 serial communication port located on the rear panel. The software is encrypted, and download verification steps ensure that the code is properly decrypted and functional. The download process does not typically erase or overwrite user-defined presets.

System software updates are provided on floppy disk for PC-based systems. Future updates may also be provided through modem downloads.

**CAUTION: Existing system software and setup parameters (but not user generated presets) are deleted during download. Model Twos are supplied with a floppy disk containing the installed system software version to allow reloading. If you are not familiar with using and setting up Windows on a PC, you should have someone else who is perform this procedure, or call Pacific Microsonics for help.**

### Required Equipment

To download new system software, the following items are required:

1. The new Model Two system software version, provided as a hex format ASCII file, which is contained in the software distribution floppy disk.
2. A PC running Windows 3.11 or Windows 95/98. The PC must be able to send & receive ASCII files over an RS-232 serial communication port at 9600, 19200, 38400 or 57600 baud rates.

3. An RS-232 null modem serial data communication cable, such as a Laplink cable (the correct cable is included with the Model Two). The Model Two has a DB-9 male connector which is configured as a computer (DTE), not a modem.

### Download Procedure

- 1) Set up the Windows communication program to send/receive at an appropriate baud rate. Load the new Model Two software from the floppy onto the PC. For information on setting up the Windows com program, see Appendix on page 73.
- 2) Connect the null modem cable between the PC's Com 1 serial data port and the Model Two's DB-9 serial data port.
- 3) From the Model Two's Operating Menu, select (SETUP/MORE.../MORE...) to get to page 3 of the Setup Menu. Initiate the system software download procedure by selecting (DOWNLD). The following menu will appear:

```

SETUP MENU
ANAL OG TO 44 1
OUT
OUT
REF
Download new system file?
Press ENTER to confirm, or
any other key to cancel
FF
DOWNLD TEST VERSION MORE...

```

- 4) Press the ENTER key to begin the download procedure. The message "DETECTED REQUEST TO DOWNLOAD NEW HDCD PROGRAM" will momentarily be displayed, and the following menu will appear:

```

SELECT BAUD RATE
REMAINING COMM PORT SETTING AVAILABLE
PARITY: DON'T CARE
DATA BITS: 7 or 8
STOP BITS: 1
9600      19200      38400      57600      CANCEL

```

- 5) Press function key #5 (CANCEL) to abort the download process or function key 1, 2, 3 or 4 to select the data transfer baud rate corresponding to the baud rate selected on the PC. The following menu will appear:

```

1. Connect to PC with nullmodem cable
2. Type on PC to check connection echo
3. Type uppercase GO to continue

or Press CANCEL to restart system
CANCEL

```

- 6) Type random characters on the PC keyboard and verify that they appear on its screen. If the characters do not appear, check the setup. The problem may be with the Windows communication program or cable. Typing "GO" on the PC will continue the download procedure and will dump all current system software. DO NOT TYPE "GO" UNLESS YOU ABSOLUTELY WANT TO DOWNLOAD A NEW VERSION OF SYSTEM SOFTWARE. Press CANCEL to abort the download process. After "GO" is typed on the PC, the message "ERASING FLASH ROM" will momentarily appear. A version of the following menu will then appear:

```
BEGIN SENDING NEW HDCD HEX FILE
AT:57600,N,7/8,1
```

- 7) Using the Windows communication program, instruct the PC to transfer the new file. See Appendix on page 74. During transfer a series of asterisks "\*" will be displayed on the PC screen. When file transfer is complete, the message "DOWNLOAD SUCCESSFUL" will momentarily be displayed on the Model Two. The Model Two will then automatically reboot. From the Operating Menu select (SETUP/PRESETS), and load the first factory preset, AD1X-24. **Then from the Operating Menu select (SETUP/MORE.../MORE.../TEST). Select ADT and set ADL to MX. Select DAT and set DD to PO. Set ALL other Test Menu selections to NORMAL!** **NOTE: It is critical that this is done to ensure correct operation!**
- 8) To verify that the new system software has been properly loaded, check the Software Version Menu. From the Operating Menu select (SETUP/MORE.../MORE.../VERSION). Look to see that the version number on the menu matches that of the newly downloaded software. (Example shown below.)

```
SOFTWARE VERSION: 3.00 10/31/00

FPC HW: f.e
DSP HW: f.e
DIO HW: f.e
FPM TYPE 509
```

## Self-Test

The Model Two goes into Self-Test mode during power-up. Any faults will be indicated on the System Status Indicator, Clock Indicators, or Graphic Display.

---

## HDCD Overview

---

The HDCD® (High Definition Compatible Digital®) process utilizes a sophisticated encoding/decoding system that greatly reduces both additive and subtractive distortions in digital audio recordings, while remaining compatible with all PCM digital formats, including Compact Disc and DVD-Audio.

The extraordinary fidelity of the HDCD process is achieved by identifying and correcting previously misunderstood (or unknown) sources of distortion in digital audio reproduction. These include both additive artifacts of the analog-to-digital and digital-to-analog conversion and filtering processes that occur with all digital formats, and subtractive distortions resulting from insufficient data present in the 44.1 kHz, 16-bit sampling of the Compact Disc format. The HDCD process effectively cancels the additive distortions and simultaneously provides additional data to reduce the subtractive distortions. The resulting recordings rival, in resolution and freedom from distortion, the finest analog master tapes, and are compatible with consumer digital audio playback formats and equipment.

HDCD process techniques and terminology are defined in the following sections.

### 16-bit Encoding

Most of the intelligence of the HDCD process has been incorporated in the Model Two HDCD Processor, lowering the cost to implement HDCD decoding in consumer equipment. An analog signal fed to the Processor is converted into a digital signal having a 24-bit word length and a sampling frequency of 176.4 kHz. After decimation to 88.2 kHz, a continuous, real-time analysis of the signal is made using DSP to determine what elements beyond the range of conventional 16-bit, 44.1 kHz, formats are perceptually important. The analysis uses algorithms derived from Pacific Microsonics' research on psychoacoustics and the mechanisms of auditory perception.

Once the perceptually important high-resolution information is identified, it is encoded into a Compact Disc standard, 16-bit, 44.1 kHz, linear PCM signal using two methods. Part of the information is added directly to the 16-bit signal by optimizing utilization of its linear bits, and part is hidden in the LSB of the 16-bit signal. Over time, less than 5% of the LSB is used for the hidden code. The encoded information is inaudible and causes no perceptible loss of information.

### 16-bit Decoding

When an HDCD encoded signal is fed to conventional playback equipment, the additional information in the signal is perceived as a clear improvement in fidelity. When the same signal is fed to an HDCD decoding system, the information hidden in the LSB tells the system that the signal is HDCD encoded, and directs the decoding to reconstruct the high

resolution signal, which is then output in the correct form for the D/A converter being used. Decoding can be performed by the Pacific Microsonics PMD-200 HDCD decoder DSP ASIC, other ASIC's including a one chip HDCD decoder and 24-bit D/A converter from Burr-Brown, and HDCD coded DSP based chips from Motorola, Analog Devices, Zoran, Mediamatics, Crystal Semiconductor and others.

There are two subsets to the HDCD process, 16-bit amplitude domain encoding and time domain encoding. The Model Two provides the option of turning off decoding of the 16-bit amplitude domain functions of the HDCD process for monitoring purposes. This is done in either the Second Operating Menu, Levels Menu, or Monitor Setup Menu. See pages 41 - 43, and 61 for additional information. Time domain decoding is automatic with HDCD decoder filtering and cannot be turned off.

## HDCD Indicator

The HDCD Indicator on the Model Two consists of a blue or amber LED back lit HDCD logo. For additional information, see the HDCD Indicator description on page 18.

## Peak Extension and HDCD Limiting

Peak Extension is normally used when converting analog or high resolution 24-bit or 20-bit digital signals to HDCD 16-bit amplitude encoded signals. Peak Extension is a digital soft limiter, with a curve that mimics analog tape saturation, except that on decoding the peaks are restored. Peak Extension can be used for several purposes: to provide headroom to capture occasional peaks or as a method to raise the average signal level to create a "hot" recording. Peak extension allows raising the average level of a recording as much as 6 dB without overload. Of course, like any limiter, if overused it can produce audible distortion when not decoded. Decoding restores the limited peaks, eliminating any distortion that might be audible. Therefore, whenever peak extension is used, the output should be monitored with HDCD 16-bit amplitude decoding both on and off to determine how much peak extension is appropriate. Peak Extension does not need to be used when the original program material has limited dynamic range.

HDCD Limiting is identical to Peak Extension except HDCD Limiting is not undone by HDCD playback decoding, and is used for its limiting effect with all types of playback.

The Model Two HDCD Processor has Peak Extension Meters which indicate the extended dynamic range available when in HDCD Peak Extension or HDCD Limiting modes. The Peak Extension meters are only active when monitoring HDCD 16-bit amplitude encoded signals that contain peak extension. With HDCD Limiting, the Peak Extension Meters only indicate during recording. Peak Extension and HDCD Limiting can be turned On or Off in the Second Operating Menu or the Digital Output HDCD Setup Menu. The default is Off. See pages 35,

41 and 51 for additional information.

## Low Level Extension

Low Level Extension is an average signal level based, low level compression/expansion system used on HDCD 16-bit amplitude encoded recordings which very gradually raises gain a preset amount when the average signal level drops below a preset threshold. During HDCD 16-bit decoded playback the compression curve is expanded back to linear gain by the HDCD decoder, using a precisely mapped inverse of the curve controlled by a hidden code, producing a dynamic range and resolution floor beyond 16-bit. Low Level Extension can be turned On or Off in the Second Operating Menu or the Digital Output HDCD Setup Menu. The default is Off. See pages 36, 41 and 51 for additional information.

## Gain Scaling

HDCD 16-bit recordings using peak extension, when decoded, have an increase of 6 dB in headroom compared to 16-bit recordings without peak extension. Therefore, it is necessary to scale their playback level up by 6 dB to match the average level of non-peak extended 16-bit recordings. Gain scaling is accomplished in the digital domain by the Model Two, which reduces the monitor level by 6dB whenever a 16-bit signal without peak extension is detected. Gain Scaling can be set to On (automatic) or Off in the Monitor Setup Menu or the Second Operating Menu. When monitoring 24-bit or 20-bit signals, Gain Scaling is normally Off. When monitoring 16-bit signals, scaling is normally On (automatic) and monitor gain is increased by 6 dB for HDCD signals with Peak Extend. See pages 42, 57 and 61 for additional information.

## Processing HDCD 16-bit Signals

When digital processing of an HDCD encoded 16-bit signal is needed, the Model Two is first used to convert it to a 24-bit or 20-bit word length. When editing or processing is completed, the Model Two is used again to convert the signal back to HDCD 16-bit.

Any process or signal path through which HDCD 16-bit amplitude encoded signals are passed must not affect the bit structure of the signal. Digital processing which alters the data will destroy the HDCD encoded information located within the LSB of the signal. Digital processing includes any level changes, EQ, dither, etc. Butt splices or rapid cross fades are allowable, but certain rules apply. For additional information see page 33.

## HDCD Silence

HDCD Silence is automatically generated by the Model Two HDCD Processor when it produces HDCD encoded output with no input program audio. HDCD silence contains dither and HDCD code within the LSB of the signal which tells an HDCD decoder that it is an HDCD signal. For additional information see page 33.

---

## Technical Specifications

---

### *Analog Inputs 1 and 2*

Connectors: XLR-3-31; Polarity: pin 2 or 3 high (software selected); Sensitivity: +12 dBu to +24 dBu full scale; Impedance:  $\geq 13 \text{ k}\Omega$  balanced; CMRR: > 80 dB DC to 1 kHz, > 60 dB at 20 kHz.

### *Analog Outputs 1 and 2*

Connectors: XLR-3-32; Polarity: pin 2 or 3 high (software selected); Level: +18 or +24 dBu full scale, set with analog attenuator. All other levels are set by digital attenuation in 0.188 dB steps at 44.1 kHz and 48 kHz. At 88.2 kHz and above, digital attenuation is in 0.1 dB steps.; Impedance: 20  $\Omega$  balanced.

### *Digital Inputs 1 and 2*

Signal Format: AES3 16-bit to 24-bit, single wire at 44.1 kHz and 48 kHz, single wire or two wire at 88.2 kHz and 96 kHz, two wire at 176.4 kHz and 192 kHz; Connectors: XLR-3-31; Level RS-422; Impedance: 110  $\Omega$  balanced.

### *Digital Outputs 1 and 2*

Signal Format: AES3 16-bit, 20-bit, 24-bit, single wire at 44.1 kHz and 48 kHz, single wire or two wire at 88.2 kHz and 96 kHz, two wire at 176.4 kHz and 192 kHz; Connectors: XLR-3-32; Level: RS-422; Impedance: 110  $\Omega$  balanced. (Output 1 and 2 word lengths may be independently set at 44.1 kHz and 48 kHz)

### *Digital Reference Input*

Signal Format: AES3 16-bit to 24-bit, 44.1 kHz, 48 kHz, 88.2 kHz and 96 kHz; Connector: XLR-3-31; Level: RS-422; Impedance: 110  $\Omega$  balanced.

### *Word Clock Input/Output*

Signal Format: 44.1 kHz, 48 kHz, 88.2 kHz and 96 kHz square wave; Connector: BNC; Input Level: TTL; Impedance: 75  $\Omega$ . Model Twos have isolated high impedance bridging word clock inputs and require an external 75  $\Omega$  termination. This allows multiple units to be "daisy chained" for synchronous operation with the last unit in the chain terminated by 75  $\Omega$ . The 75  $\Omega$  word clock output is AC coupled to prevent ground loops and can be connected to most equipment with CMOS "TTL compatible" 75  $\Omega$  word clock inputs.

### *Serial Data I/O*

Signal Format: RS-232; Connector: D-Sub 9-pin, DTE. (Used for downloading system software from an external source)

## *User Set-Up and Operating Interface*

A backlit, dot matrix graphic display, rotary optical encoder, and soft-configured switches allow multimode, multilevel, software based configuration of all setup and operating parameters. Multiple setup configurations may be loaded into user labeled presets for instant access.

## *Signal Level Meters*

Two channel, 66 dB range, four color LED bar graph. "Peak" and "Over" indication are selectable for duration and sensitivity, reference level is variable from -6 dB to -21 dB in 1 dB steps, reference level set mode provides .2 dB per segment resolution, calibrated digital signal word length display mode, 6 dB HDCD 16-bit "Peak Extend" level indication, display reset, variable brightness. Peak bar or simultaneous average bar with peak dot display modes.

## *HDCD Signal Processing*

Eight Motorola 56009 DSPs and one Pacific Microsonics PMD-100 HDCD decoder ASIC control A/D conversion, sampling rate conversion, word length conversion, digital gain adjustment, HDCD encoding and decoding and D/A conversion.

## *A/D and D/A Conversion Reclocking*

Jitter rejection knee: A/D < 1 Hz (jitter reduction at 100 Hz > 80 dB), D/A < 2.5 Hz.

## *AC Power Requirements*

100/120/220/240 V + 5% - 10%, 50/60 Hz, 200 Watts.

## *Dimensions*

Processor Unit: 5.25" H x 19" W x 19.5" D (133 mm x 483 mm x 495 mm)  
Enclosure is 17" W (432 mm) behind front panel.

Power Supply: 2.5" H x 14" W x 12.25" D (64 mm x 356 mm x 311 mm)

## *Weight*

Processor Unit: 35 lbs. (16 kg.)  
Power Supply: 20 lbs. (9 kg.)  
Custom ATA Case: 41 lbs. (19 kg.)



## Appendix

---

### Setting Up Communications on a PC Using Windows 3.11

Start Windows and open up the Accessories Program Manager Box, by double clicking on the Accessories Icon. Double click on the Terminal Icon. Using the communications program's pull down menu, select "Settings". Select the following settings:

COMMUNICATIONS  
Baud Rate = 19200  
Data Bits = 8  
Stop Bits = 1  
Parity = None  
Flow Control = None  
Connector = COM1

TERMINAL EMULATION  
DEC VT-100 [ANSI]

TERMINAL PREFERENCES  
Local Echo = Off

Click on "OK" to accept these settings. The Windows communications program is now in terminal mode with a direct connection to Com 1.

### Setting Up Communications on a PC Using Windows 95/98

Start Windows and go to the Start Icon, then Programs, then Accessories, then Communications, and finally HyperTerminal. The HyperTerminal Dialog Box will open. Select the Hypertrm.exe program icon by double clicking on it. The HyperTerminal communications program will start. (Assign an easy to remember name to the connection configuration file you are creating - you may be using the same program and connection configuration file to upgrade Model Two software in the future).

The Connect To option box will open. Select "Direct to Com 1" then click on "OK" to accept. The Com 1 Properties Box will open. Select the following settings:

Baud Rate = 57600  
Data Bits = 8  
Stop Bits = 1  
Parity = None  
Flow Control = None

Click on "OK" to accept these settings. Go to the Windows communication program's pull down menu item "File", and then "Properties". The 'configuration file name' Properties Dialog Box will open (where the configuration file name will be the name you have selected). Select the "Settings" Tab, then "ASCII Setup" Box. The ASCII Setup Dialog Box

will open. Make sure that the "Echo typed characters locally" box is not checked. Click on "OK" to accept these ASCII settings, then click "OK" again to accept the 'configuration file name' properties. The Windows HyperTerminal program is now in terminal mode with a direct connection to Com 1.

## Beginning File Transfer from the PC

Using the Windows communications program pull down menu, select "Transfer", then "Send Text File". The Send Text File Dialog Box will be displayed. Select "All File Types" and navigate to the subdirectory that contains the Model Two software file to be downloaded. Scroll to the file and highlight it. Press "Enter" on the PC's keyboard to begin downloading. During downloading, the Windows communication program screen will have a series of asterisks "\*" scrolling across it. Downloading will take approximately 6 minutes at 19200 baud or approximately 3 minutes at 57600 baud. When the Windows communications program has finished downloading the file, it will display "DONE" on the PC screen. At the same time, the Model Two will display "DOWNLOAD SUCCESSFUL" and then automatically reboot to load the new software.

**CAUTION: After installing new software in the Model Two it is essential to verify that all Test Functions Menu settings are correct using the following procedure:**

From the Operating Menu select (SETUP/PRESETS), and load the first factory preset, AD1X-24. Then from the Operating Menu select (SETUP/MORE.../MORE... /TEST). **Select the ADT sub-menu and set ADL to MX. Select the DAT sub-menu and set DD to PO. Verify that ALL other Test Functions Menu and sub-menu selections are set to NORMAL!**